



**SCHWINN**

# Core Health & Fitness

Schwinn Echelon2

---

**SERVICE  
MANUAL**

---

By following the enclosed instructions and maintenance schedule, you will extend the life of your bikes and help ensure the equipment will function properly during use.

### **Before working on this equipment, pay attention to the following warnings:**

- Read and understand the complete Owner's Manual.
- Keep Owner's Manual for future reference.
- Read and understand all warnings on this machine. If at any time the Warning stickers become loose, unreadable or dislodged, contact Customer Service for replacement stickers.
- Keep children away from this machine. Monitor them closely when near the machine. Parts that move and appear dangerous to adults can appear safe to children.
- Consult a physician before you start an exercise program. Stop exercising if you feel pain or tightness in your chest, become short of breath, or feel faint. Contact your doctor before you use the machine again. Use the values calculated or measured by the machine's computer for reference purposes only.
- Before each use, examine this machine for loose parts or signs of wear. Do not use if found in this condition. Monitor the Seat, Pedals, and Crank Arms closely. Contact Customer Service for repair information.
- Maximum user weight limit: 350lbs. (159kgs). Do not use if you are over this weight.
- Do not wear loose clothing or jewelry. This machine contains moving parts.
- Set up and operate this machine on a solid, level, horizontal surface.
- Do not step off the machine until the Pedals have fully stopped. Use the Resistance Adjustment Knob to slow the Pedals to a controlled stop before you step off the machine.
- Do not operate this machine outdoors or in moist or wet locations.
- Keep at least 19.7"(0.5m) on each side of the machine clear. This is the recommended safe distance for access and passage around and emergency dismounts from the machine. Keep third parties out of this space when machine is in use.
- Do not over exert yourself during exercise. Operate the machine in the manner described in this manual.
- When the machine is put in a studio or club environment, it can only be used in areas where access and control of the machine is managed by approved staff. The degree of management depends on the user's ability to recognize and prevent danger to third parties during the exercise movement.

### **Tools Required**

The tool list below is needed to repair and perform preventative maintenance on all Schwinn bikes.

- PEDAL WRENCH
- CRANK ARM REMOVAL TOOL
- ISIS DRIVE BB TOOL (BBT-18)
- SMART RELEASE REMOVAL TOOL
- CRANK ARM REMOVAL TOOL
- 3/8 DRIVE RATCHET (QTY 2)
- 3/8 DRIVE EXTENSION (3 INCHES)
- 14MM SOCKET 3/8 DRIVE
- 15MM SOCKET 3/8 DRIVE
- 21MM OPEN ENDED WRENCH
- LONG PHILLIPS SCREW DRIVER
- STANDARD PHILLIPS SCREW DRIVER
- 1/2 DRIVE RATCHET
- 3MM T HANDLE ALLEN HEAD
- 26MM SOCKET 1/2 DRIVE SOCKET
- 5/16 ALLEN HEAD SOCKET 3/8 DRIVE
- 17MM OPEN ENDED WRENCH
- 5/32 ALLEN HEAD SOCKET 3/8 DRIVE
- 14MM OPEN END/BOX END WRENCH
- 6MM ALLEN HEAD SOCKET 3/8 DRIVE
- 8MM ALLEN HEAD SOCKET 3/8 DRIVE
- 10" CRESCENT WRENCH
- CHAIN WEAR INDICATOR
- TEFLON SPRAY
- WHITE LITHIUM GREASE

## Echelon2 Console

- [What's in the Box](#)
- [General Features/Functions](#)
- [Installation of the Schwinn® Echelon2 Console System](#)
- [Zeropoint Calibration Procedure](#)
- [Echelon2 Post-Install Checklist](#)
- [Power Validation Table](#)
- [Menu Map](#)
- [Wiring Diagram and Signal Flow](#)
- [Preventative Maintenance](#)
- [Troubleshooting and Service](#)
  - Console Not Displaying RPMs
  - Console Not Displaying Watts / Power / Calories
  - Watts / Power is too low/high
- [FAQs](#)
  - Loading Firmware
  - Setting a Passcode

## What's in the Box?

### SCHWINN® Echelon2 (Part #740-8727)



*Package includes components listed below*

Index	Part Number	Description	QTY
1	740-8727	SCHWINN® Echelon2	N/A
1.1	110-3640	SCREW, PHP, M4x0.7x10, SS	3
1.2	110-3641	SCW-BHCS M5x0.8x14 SS	2
1.3	110-3642	SCREW, M3X0.5,12mm, SHC, HK, SS,GR 8.8	2
1.4	110-3643	SCREW, M3X0.5,6mm,RHM,PH,SS	1
1.5	140-3585	KIT,WIRE SADDLE CLIP, ECH 2	1
1.6	740-8727	016 BOX, MPOWER Q	1
1.7	740-8822	SRB, MPOWER Q, RECTANGLE HOLE	1
1.8	740-8925	ASSY, SCHWINN® Echelon2,COMPUTER	1
1.9	740-8926	SPEED SENSOR ASSY, WIRED	1
1.1	740-8927	COSMETIC CAP ASSY	1
1.11	740-8928	RJ45 2-PIN LONG CABLE	1
1.12	740-8929	MOUNT, M POWER Q	1
1.13	740-8930	SRB MOUNT, M POWER Q	1
1.14	740-8938	CD,OWNERS/INST MANUAL,ECH 2C7	1



### SCHWINN® Echelon2 Power Upgrade Kit (Part #740-8730)

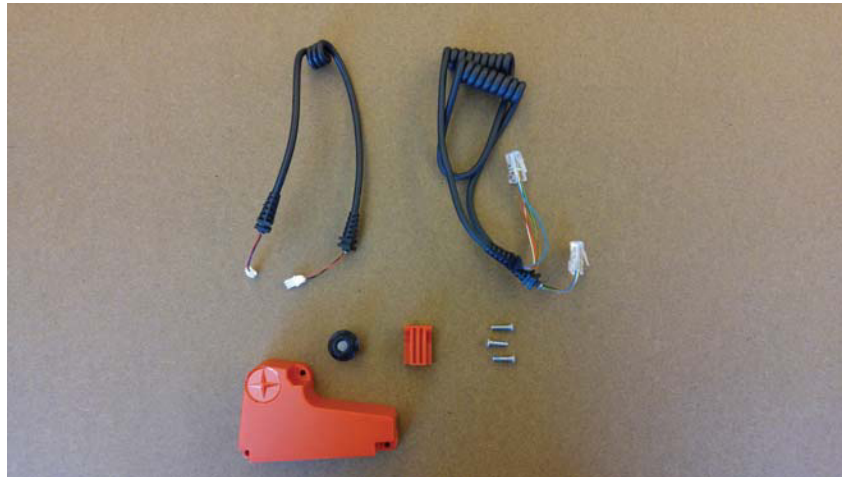

*Package includes components listed below*

Index	Part Number	DESCRIPTION	QTY
1	740-8730	SCHWINN® Echelon2 POWER UPGRADE	N/A
1.1	110-3644	SCREW, M4X0.7X14, BHSC,HE,SS	3
1.2	740-8607	CALIBRATION TOOL, ZERO POINT, ACP	1
1.3	740-8730-005	POWER SENSOR UPGRADE PACKAGING	1
1.4	740-8931	POWER UPGRADE CABLE, RJ45	1
1.5	740-8932	2-PIN SHORT SPEED SENSOR CABLE	1
1.6	740-8933	ASSY, MAGNET, SENSOR, ECH 2	1
1.7	740-8934	ASSY, ECH2 POWER	1
1.8	740-8935	PAD,RUBBER,POWER SENSOR	1

**SCHWINN® Echelon2 External Wire Kit (Part #740-8875)**



*Package includes components listed below*

Index	Part Number	Description	QTY
1	740-8875	KIT, EXTERNAL WIRE, Echelon2	N/A
1.1	740-8875_001	EXTERNAL CABLE COVER ASSY	2
1.2	740-8875_005	CABLE CLAMP	1

## Echelon2 Features and Functionality

The Echelon2 provides riders with real-time user metrics that can be used to improve the current and future workouts. Watts, time, kcal, distance, RPMs, speed, distance, and heartrate are displayed on an intuitive display that allows for ease of use during high intensity rides.

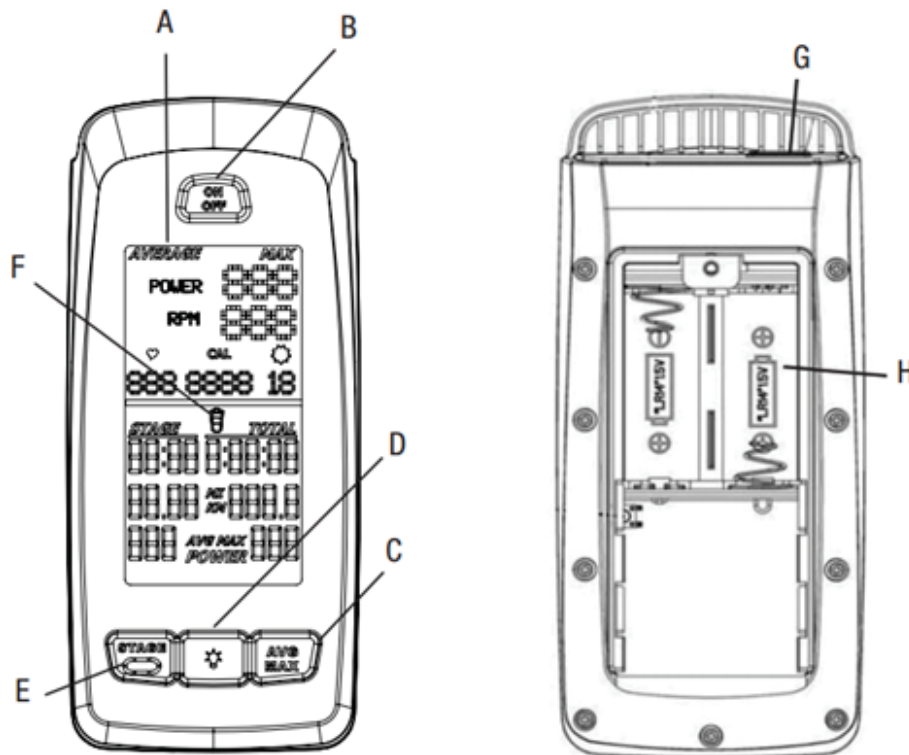

A	Backlit LCD Display	F	Battery Level
B	ON/OFF Button	G	USB Port
C	AVG/MAX Button	H	Battery Bay
D	Backlight Button		
E	STAGE Button		

### Backlit LCD Display

During the workout, the multi-function, backlit LCD shows your workout measurements, results, user setup data and console diagnostics.

To turn on the backlight, push the Backlight button. The backlight turns off after 10 seconds to conserve the batteries. This backlight setting can be adjusted in the Service menu.

### Heart Rate Monitor

The console receives heart rate data from the heart rate monitor (HRM).

The console can read heart rate data from an ANT+ 2.4GHz or Polar® compatible 5kHz wireless chest strap.

- **ANT+ 2.4GHz Wireless:** The ANT+ 2.4GHz Wireless Heart Rate Monitor (HRM) sends heart rate data to the console after proximity linking automatically occurs after console startup. The console can read the HRM data to a distance of 118" (3 m) during Workout Mode. If you have a compatible paired ANT+ Sport Watch and ANT+ HRM, the console links with the Sport Watch and reads the heart rate data from it, if the watch is compatible. The Schwinn console uses the ANT+ Fitness Profile. Visit [www.thisisant.com](http://www.thisisant.com) for a directory of compatible devices
- **Standard EM 5kHz Pulse:** The console uses the EM (electromagnetic) 5kHz pulse wireless protocol to read heart rate data from the standard heart rate monitors (HRMs), such as a Polar® transmitter chest strap.

### Workout Data Storage

The console sends workout data to the user's data storage device -- for example, a USB flash memory device or a sport watch.

- **ANT+ Sport Watch for Data Storage:** During Workout Mode the console sends workout data to the ANT+ Sport Watch. When the proximity linking is complete, the watch and console can send and read data up to 118" (3 m). Visit [www.thisisant.com](http://www.thisisant.com) for a directory of compatible devices.
- **USB Interface / Data Storage:** During Workout Mode the console sends workout data to the USB device:
  - Workout (total) -- Time, Distance, Calories, Power, RPM, Avg Power, Max Power, Avg
  - Workout Stages -- Time, Distance, Avg Power, Max Power, MAX RPM. Consoles with firmware V1.1 and later will also report AVG and MAX heart rate for each stage.

**NOTE: If you connect the USB device after the workout ends, the console only sends the Total Summary data to the USB device. Workout Data is stored as a .csv file with the name MPOWERXX.csv, where XX is the two-digit number from 1 to 99. The console will automatically save using the next available number on the USB device if files are already present.**

The USB port also gives access to update the console firmware by a Service Technician. There is a USB symbol that will flash next to the RPM when the console is uploading data to the USB stick. The stick must remain in the plug as long as the USB symbol flashes. Once the symbol stops flashing, the stick can be removed.

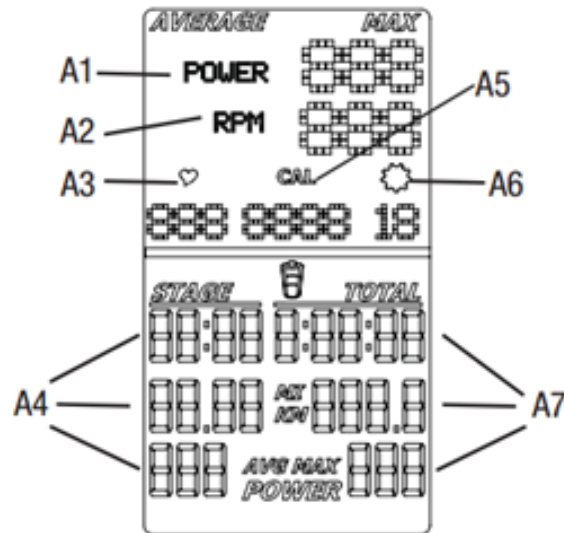

A1	POWER (Watts)	A5	Cal (Calories)
A2	RPM (Cadence)	A6	Gear Indicator
A3	Heart Rate	A7	TOTAL Time, Distance and Power
A4	STAGE Time, Distance and Power		

## Power

The power display field shows the Power in Watts that you are producing at the current resistance level (1 horsepower = 746 Watts). Power data only shows if there is a power sensor installed on the bike.

## RPM

The RPM display field shows the current pedal revolutions per minute (RPM).

## Heart Rate

The Heart Rate display field shows the heart rate in beats per minute (BPM) from the heart rate monitor (HRM). When the computer is ON, it will search for a signal from a compatible heart rate strap for 30 seconds. During this time, the HR symbol will flash. If a strap is detected, the HR symbol will stop flashing and remain solid while displaying the HR. If a signal is not detected after 30 seconds, the HR symbol will disappear. The user may reinitiate the pairing process by pressing and releasing the ON/OFF button.

**Heart Rate Note:** The heart rate monitor is not a medical test, nor is it designed as a medical test. It is simply a guide to target heart rate training. Please consult with your physician prior to engaging in any strenuous physical activity. Schwinn does not warranty the heart rate system performance on this product, as the heart rate system performance varies based on a user's physiology, fitness level, age, method of use, and other factors.

## Calories

The Calories display field shows the estimated calories that you have burned during the exercise. This value is calculated based on POWER if a Power Sensor is installed. Calories are not calculated if a power sensor is not installed. Consoles with firmware V1.1 or later have the ability to turn the CAL display OFF in the service menu.

## Workout Stage

The STAGE display field shows the time, distance and AVG/MAX power in the current Stage of the workout. Time and distance values start at zero and count forward until the end of the Stage. Power is averaged for the current stage.

## Gear

The gear display field shows a number from 0-36 indicating resistance level. The gear display can be turned OFF in Service Mode.

## Workout Totals

The TOTAL display field shows the total time, distance and avg/max power for the entire workout period.

## Keypad

The multi-function keypad lets you set the console measurements for your workout, see and update your workout data, and examine the console diagnostic messages. Tap the ON/ OFF button to activate the console from Sleep Mode. The Operations section of this manual gives you the procedures for using the buttons in each Operations mode. The Backlight button sets your selections during the ride and in Service Mode.

## Battery Level

The Battery Level icon shows the battery level for the console. All four segments of the icon are on when the battery level is high. When the battery level is low, only the bottom segment is on. The bottom segment flashes when battery level is very low.

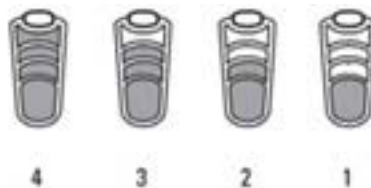

If the battery level is too low to continue operation, the console display flashes the message “LO batt” and the console goes into Sleep Mode. If this occurs during a workout, the workout stops and the console display shows the workout results for 10 seconds. Then the “LO batt” message displays and the console goes into Sleep Mode.

## Bike Sensor Data

The console receives data from the bike’s sensors and uses the data to calculate workout results.

- RPM Sensor: The Schwinn® console comes with a RPM sensor for the bike. This sensor transmits data from the flywheel to the power sensor and the console.
- Power (Watts) Sensor: The Power sensor is an optional upgrade. The power sensor calculates rider Power (Watts) production from the brake resistance mechanism.

## Pause Mode

During the ride, the console collects user data to calculate and record workout data. Proximity linking to the user’s HRM or ANT+ watch also automatically occurs after console startup..

Use the appropriate instruction for monitoring equipment.

- USB storage device --install the device in the USB port.
- ANT+ watch --link to the console. Move the watch to 2”-4” (5-10 cm) or less from the ANT+ Link Here icon on the console and hold it there until proximity linking is complete.
- ANT+ HRM --link to the console. Lean into the console so that the HRM is 7.5”-31” (20-80 cm) from the ANT+ Link Here logo, until a value is displayed.

**Note: If you have an ANT+ Sport Watch and paired ANT+ HRM, it is only necessary for the console to link with the sport watch. However, if you have an ANT+ Sport Watch and EM 5kHz HRM, the console links to the watch and the HRM. Visit [www.thisisant.com](http://www.thisisant.com) for a directory of compatible devices. The Schwinn console uses the ANT+ Fitness profile.**

ANT+  
Watch



HRM



## Zeropoint Current Angle Quick Check

Software V1.7 adds a new feature that allows users to quickly check the current angle of the Zeropoint Calibration from the main Ride menu. This enables riders to quickly check to verify the sensor is still calibrated without having to navigate through the service menu.

To do the quick check:

1. Place the calibration tool on the flywheel.
2. Turn the brake knob clockwise until the brake stops.
3. From the main Ride menu, hold the LIGHT button for 3 seconds.

The console will display the Zeropoint angle for 10 seconds, after the 10 seconds the console will return to the main Ride menu.

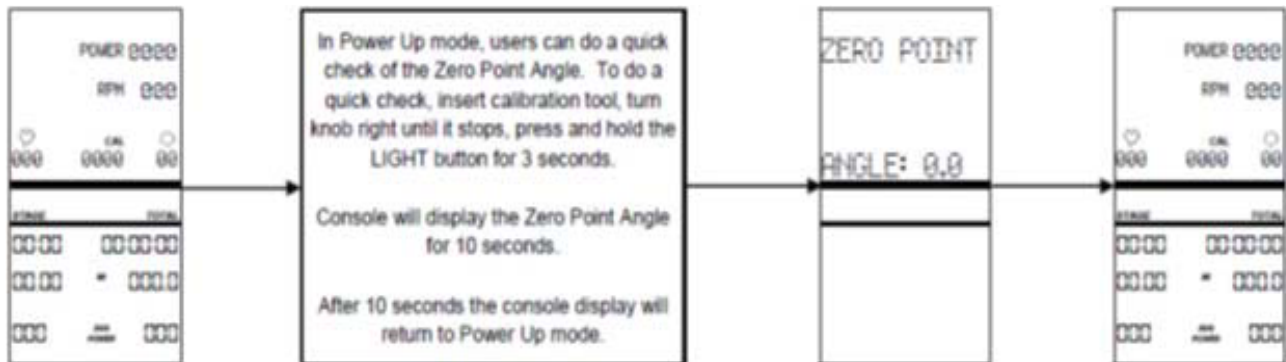



## Installation of the Schwinn® Echelon2 Console System

### Tools Required:

- Phillips Screwdriver
- 2.5mm Allen Key
- 3mm Allen Key
- Soft-jaw Pliers (pliers with protective rubber or plastic covering jaws)

**WARNING:** Do not use power tools for any part of the installation of the console, power sensor, or related components. Power tools may cause irreparable damage by over torquing the screws and damaging components such as plastic components. Also over torquing screws with hand tools can cause damage to plastic components, or strip the heads of the hardware.

### *AC Sport™ and AC Performance™ Installation*

**NOTE:** If installing the console with the optional power upgrade at the same time as the console, review the instructions in the section “Optional Power Upgrade Kit Installation on AC™ Sport and AC™ Performance Bikes” before proceeding with the steps in this section.

1. Insert batteries into console



2. Mount the console bracket using the two (2) M5 x 14mm button head screws.



3. Tighten the screws using the 3mm hex key

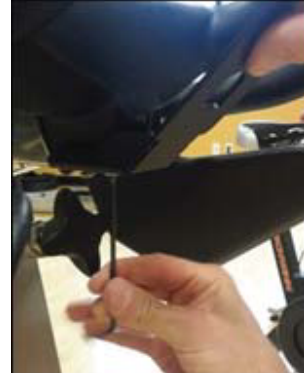

4. Slide the console onto the bracket. Insert the M3 x 6mm pan head screw and tighten with the screw driver



5. Prior to installing the upper conduit, clean head tube with isopropyl alcohol. Allow to air dry.

6. Peel off backing adhesive and align duct part number 740-8875-001 to forward edge and lower edge of the frame tube. Apply normal pressure for 5 seconds

**Note: It is recommended that the adhesive set for 24 hours before use.**

7. Insert the cable through the slot



8. Snap the outer part of the cable duct onto the base with the cable inside



9. Using a philips screw driver, remove the sweat guard (Do not use a power drill in removing and re-installing)



10. Route the cable through the sweat guard



11. Re-mount the sweat guard



12. Plug the console cable RJ45 connector into the console then slide the grommet of the cable into the slot on the connector protective cap as shown

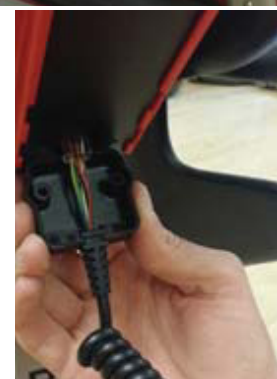
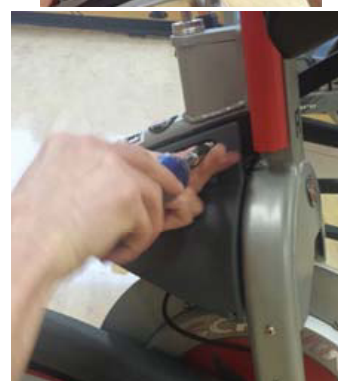

13. Attach the protective cap to the bracket using the two (2) M3 x 12mm socket head cap screws, and tighten with the 2.5mm hex key



14. Attach the RPM sensor adapter to the RPM sensor using the M3 x 6mm Philips Pan Head Screw



15. Unscrew the M3 x 6mm Philips Pan Head screw holding the RPM sensor cover on and remove it



16. Plug the RPM sensor cable 2-pin connector into the RPM sensor connector and slide the cable grommet into the slot in the RPM sensor housing

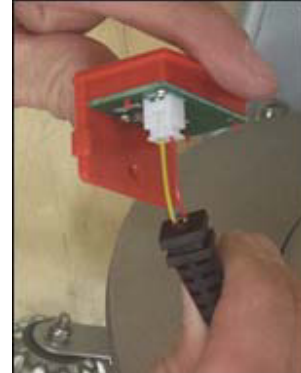

17. Reinstall the RPM sensor cover into the housing, and reinstall the M3 x 6mm Philips Pan Head screw



18. Remove the top and bottom screw from the front of the chain guard



19. Position the RPM sensor as shown and reinstall the two chain guard screws. The RPM sensor should be about 2 - 3mm away from the flywheel, or about the width of a credit card. If the RPM sensor is too close, it will rub against the sensor magnet that is embedded in the flywheel. If the RPM sensor is too far away, the sensor will intermittently pick up a signal from the magnet or will not pick up any signal at all; this will cause an erratic RPM display, or no RPM display



20. Prior to applying the lower conduit, clean the surface of the inner right fork with isopropyl alcohol and allow to air dry. Peel the non-stick strip off the plastic conduit base. Place it firmly on the inside of the right hand fork. There should be about one inch gap between chain guard/rpm sensor bracket and the wire conduit



21. Route the wire inside the conduit and snap the conduit outer cover on to the base





## AC Performance Plus™ and AC Performance Plus Carbon Blue™ Installation

**NOTE:** If installing the console with the optional power upgrade at the same time as the console, review the instructions in the section “Optional Power Upgrade Kit Installation on AC™ Performance Plus” before proceeding with the steps in this section.

1. Insert batteries into console



2. Remove handlebars from bike and place on a sturdy working surface.
3. Grab the console-to-RPM cable and note which end has the 2-pin connector.

4. Insert the end of cable with the 2-pin connector into the opening at the top of the handlebar post. Feed the cable through, with one section of coiled cable being inside the tube, and one section of coiled cable being outside the tube. The end of the cable should just be poking out of the end of the tube

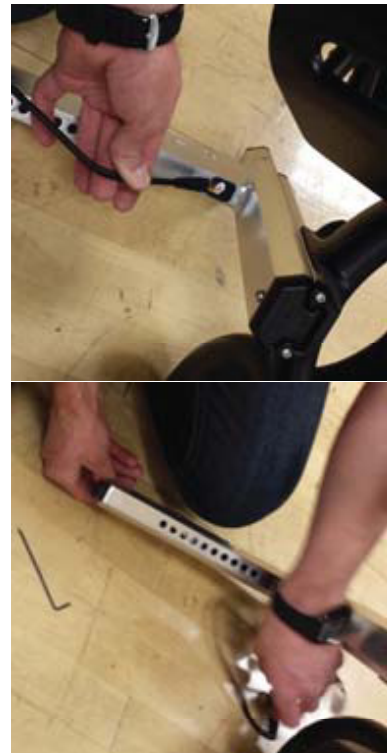

5. Place the handlebar back on the bike.

6. Feed the end of the cable out of the end of the head tube. Wear heavy-duty protective gloves when pulling the end of the cable out of the head tube as there may be sharp edges inside the head tube



7. Mount the console bracket using the three (3) M4 x 10mm Philips Pan Head screws, and tighten the screws

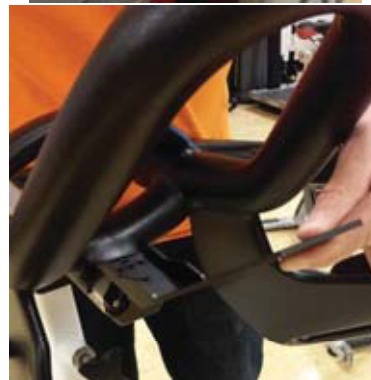

8. Slide the console onto the bracket. Insert the M3 x 6mm pan head screw and tighten with the screw driver



9. Plug the console cable RJ45 connector into the console then slide the grommet of the cable into the slot on the connector protective cap as shown



10. Attach the protective cap to the bracket using the two (2) M3 x 12mm socket head cap screws, and tighten with the 2.5mm hex key



11. Install the cosmetic cap using a M5 x 14mm BHCS

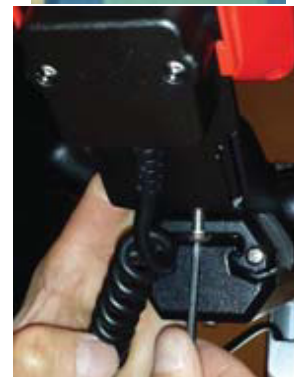

- Using a Philips screw driver, remove the sweat guard (Do not use a power drill in removing and re-installing). Route the cable through the sweat guard



- Unscrew the M3 x 6mm Philips Pan Head screw holding the RPM sensor cover on and remove it



14. Plug the RPM sensor cable 2-pin connector into the RPM sensor connector and slide the cable grommet into the slot in the RPM sensor housing

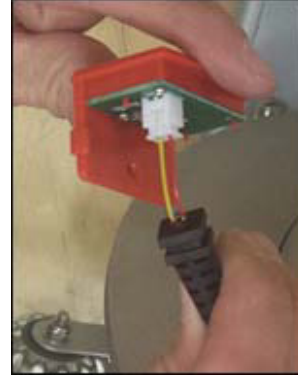

15. Reinstall the RPM sensor cover into the housing, and reinstall the M3 x 6mm Philips Pan Head screw



16. Remove the top and bottom screw from the front of the chain guard



17. Position the RPM sensor as shown and reinstall the two chain guard screws. The RPM sensor should be about 2 - 3mm away from the flywheel, or about the width of a credit card. If the RPM sensor is too close, it will rub against the sensor magnet that is embedded in the flywheel. If the RPM sensor is too far away, the sensor will intermittently pick up a signal from the magnet or will not pick up any signal at all; this will cause an erratic RPM display, or no RPM display



18. Reinstall the sweat guard then install the two cable saddle mounts to the two holes inside the left fork using the two plastic rivets



19. Secure the cable inside the two saddle clamps as shown





### ***Power Upgrade Kit Installation for AC Sport and AC Performance Bikes***

**NOTE:** When installing the power upgrade kit, do not use the console-to-RPM sensor cable (1.11: 740-8928) from the console kit. This cable is not used when installing the power upgrade kit. Use the console-to-power cable (1.4: 740-8931) in the power kit to connect the console to the power sensor. Use the RPM-to-power cable (1.5: 740-8932) in the power kit to connect the RPM sensor to the power sensor; this cable is the shorter cable with a two-pin connector on each end of the cable.



Repeat Step 1-21 from the console kit installation instructions above **with the exception of step 11. Do not remount the sweat guard.**

NOTE: The difference at this point will be that the cable from the console will not be plugged into the RPM sensor. The RPM sensor cable will have one free end after installing the RPM sensor on the bike and routing the RPM cable through the cable duct. The console-to-power cable has different lengths of unshielded wires at each end as show below and has RJ45 connectors on both ends. The end with the shorter length of unshielded wires (right) plugs into the console. The end with the longer length of unshielded wires (left) is routed through the cable duct and plugged into the power sensor.





1. Position rubber boot with magnet (magnet assembly) so that the hex pattern of the boot lines up exactly with the hex nut on the resistance mechanism.

NOTE: As of July 2016, the sensor magnet will be mounted during production at the factory.

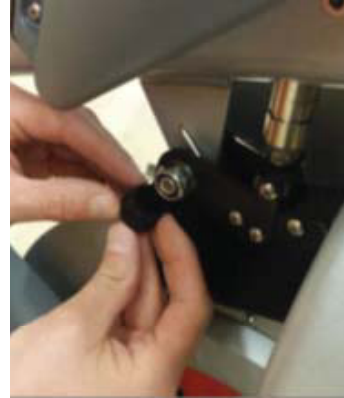

2. Slide boot onto hex nut and ensure that boot sits in contact with the black plate of the resistance mechanism



3. If the bike serial number is XXXXXXDAY1642XXXX or later, an updated bolt and magnet assembly will be installed at the factory as shown. If this updated assembly is already installed, the rubber boot with magnet mentioned in step 2 does NOT need to be installed.



4. Plug console cable into the RJ45 connector at the front of the sensor, and the RPM cable into the 2-pin connector on the underside of the power sensor. Slide each cable's grommet into their respective slots in the power sensor case



Console cable



Like This

RPM cable

5. Attach sensor case to the resistance mechanism using the M4 x 6mm button head screws. Use blue thread lock on the screws to ensure the sensor mounts fully.

NOTE: Be sure that sensor case sits tight against the black plate of the resistance mechanism. All wires must be contained within the sensor cover and not protrude from the sensor cover, which will prevent the cover from being completely seated



6. Reinstall sweat guard.

IMPORTANT: Before using the console with the power upgrade kit for the first time, the power sensor must be calibrated. [Click Here](#) for instructions on calibrating the power sensor.

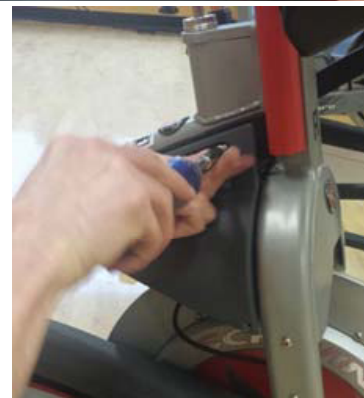

## ***Power Upgrade Kit Installation for AC Performance Plus and Carbon Blue Bikes***

**NOTE:** When installing the power upgrade kit, do not use the console-to-RPM sensor cable (1.11: 740-8928) from the console kit. This cable is not used when installing the power upgrade kit. Use the console-to-power cable (1.4: 740-8931) in the power kit to connect the console to the power sensor. Use the RPM-to-power cable (1.5: 740-8932) in the power kit to connect the RPM sensor to the power sensor; this cable is the shorter cable with a two-pin connector on each end of the cable.



1. Repeat Step 1-21 from the console kit installation instructions above **with the exception of step 11. Do not remount the sweat guard.**

**NOTE:** The difference at this point will be that the cable from the console will not be plugged into the RPM sensor. The RPM sensor cable will have one free end after installing the RPM sensor on the bike and routing the ROM cable through the cable duct. The console-to-power cable has different lengths of unshielded wires at each end and has RJ45 connectors on both ends. The end with the shorter length of unshielded wires (right) plugs into the console. The end with the longer length of unshielded wires (left) is routed through the handlebar post to be plugged into the power sensor. After routing the cable through the post, and reinstalling the post, the RJ45 connector that plugs to the power sensor will be visible.



*Unshielded Wires*



*RJ45 Connector*

2. Position rubber boot with magnet (magnet assembly) so that the hex pattern of the boot lines up with the hex nut on the resistance mechanism. Note: As of July 2016, the sensor magnet will be mounted during production at the factory.

**Note:** If the bike serial number is XXXXXXDAY1642XXXX or later, an updated bolt and magnet assembly will be installed at the factory. If this updated assembly is already installed, the rubber boot with magnet does not need to be installed so skip to step 4.

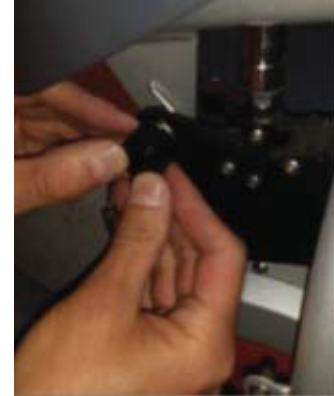
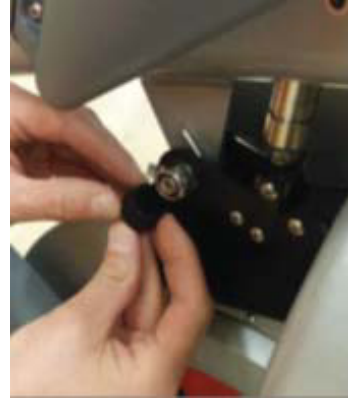

3. Slide boot onto hex nut and ensure that boot sits in contact with the black plate of the resistance mechanism.



4. Plug console cable into the RJ45 connector, and the RPM cable into the 2-pin connector on the power sensor. Slide each cable's grommet into their respective slots in the power sensor case.



5. Attach sensor case to the resistance mechanism using the M4 x 6mm button head screws. Use blue thread lock on the screws to ensure the sensor mounts fully.

**NOTE:** Be sure that sensor case sits tight against the black plate of the resistance mechanism. All wires must be contained within the sensor cover and not protrude from the sensor cover, which will prevent the cover from being completely seated



6. Reinstall sweat guard.

**IMPORTANT:** Before using the console with the power upgrade kit for the first time, the power sensor must be calibrated. [Go to the next page](#) for instructions on calibrating the power sensor.



## Zeropoint Calibration Procedure

The Zeropoint Calibration Procedure ensures that the console will display the rider status. It sets the zeropoint for the power sensor and allows the console to use a formula, with the RPMs and the angle of the brake as variables, to provide calories, power, and RPMs.

1. Power on the console

2. Enter the service menu by holding down the STAGE and AVG/MAX buttons together for about 4-6 seconds.

3. Once in the service menu, use the AVG/MAX button to scroll to the CALBRATE menu. Press and release the LIGHT button to enter the menu.

4. Scroll to CALIBRATE ZEROPOINT option and press the LIGHT button.

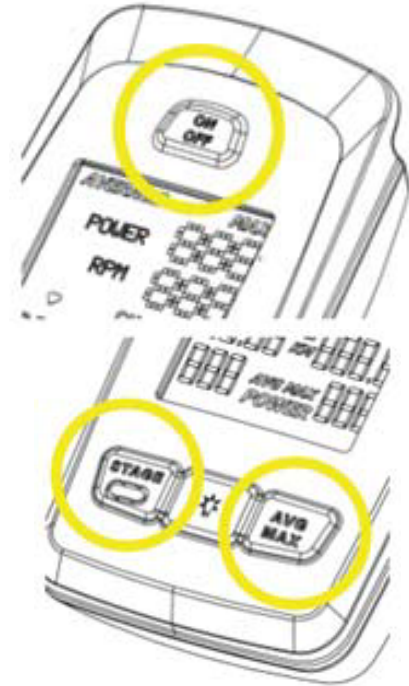



5. Follow the on-screen instructions; place the calibration tool on the flywheel, rotate back until the tool fits between the magnets of the brake assembly, and then press the LIGHT button.

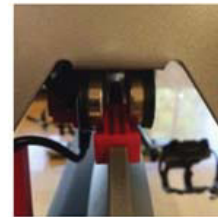

6. Turn the brake knob clockwise until the brake mechanism makes contact with the calibration tool and press the LIGHT button.

**Do not over tighten.**



7. The console will display that the Zeropoint is now set. Press the LIGHT button to exit CALIBRATE ZEROPOINT.



8. Once the calibration passes, go to CALIBRATE CURRENT ANGLE and verify the angle is 0.0 (+/- 0.1 degrees)

Occasionally, the calibration process does not correctly set the angle on the first try. If the angle reads anything other than 0.0 (+/- 0.1 degrees), perform the calibration again until the CURRENT ANGLE reads 0.0 (+/- 0.1 degrees).

Note: The sensor measures in degrees, so 0.0 – 0.1 = 359.9.



9. At this point calibration is done. Exit the service menu and remove the tool from the flywheel (keep for future use, the tool can be stored under the cosmetic bracket cover for safe keeping)





### **Echelon2 Post-Install Checklist**

- Ensure all wiring is routed properly and does not interfere with any moving parts
- Verify the RPM sensor is 2mm – 3mm away from flywheel.
- Before mounting the Echelon2 power sensor to the magnetic brake, ensure the rubber magnet cap is installed over the nut of the brake assembly if applicable.
- For Echelon2 with power sensor: [Check all magnetic resistance mechanisms and adjust as needed.](#)
- For Echelon2 with power sensor: Use the console to [run a Zeropoint Calibration](#) and verify Current Angle is set to and holding at 0.0 (+/- 0.1 degrees).
- Store the red Zeropoint calibration tool (740-8607) under the console's cosmetic cap for future use.
- If group riding software is present, [ensure the console is not displaying a duplicate ID.](#)
- [Firmware has been updated to latest version.](#)

### **Power Validation Tables**

The power validation procedure will help you determine if your Echelon2 console is reporting accurate numbers after calibrating the sensor. Follow these steps to validate the power on your Echelon2 console.

1. Do the zero point calibration, and check to verify that the current angle after calibration is between 359.9 and 0.1 degrees.
2. In the service menu, use the STAGE or AVG/MAX buttons on the console (the two outside buttons near the bottom of the console) to scroll to the GEAR menu. Press and release the "LIGHT" button (the button in the middle of the row of buttons near the bottom of the console). Press and release the STAGE or AVG/MAX buttons to select the gear ON option. Press and release the "LIGHT" button to set the gear to ON. NOTE: The gear function must be used to validate the power. If your studio does not use the gear function in its classes, then the gear display can be turned off after doing the power validation procedure.
3. Scroll to the service menu EXIT screen using the STAGE or AVG/MAX buttons, and press the "LIGHT" button to exit the service menu and return to ride mode.
4. Choose one of power validation tables below depending on if the CARBON BLUE setting is turned ON or OFF. The power values at each gear differ between CARBON BLUE ON vs. OFF due to differences in gear ratio. If a console has an ANGLE OFFSET set to any value other than 0%, temporarily set the console to 0% to conduct the test.
5. Using the appropriate power validation table below, set the ANGLE OFFSET to 0%, select a gear and an RPM, and ride at the RPM. Check the power that is displayed on the console and compare it to the power for the given gear and RPM to see if they match. After conducting the test, set the ANGLE OFFSET back to where it was set originally. NOTE: Each gear covers a range of power rather than a single discrete power value. This is normal. The easiest way to validate the power is to ride at the low end of the gear and check the power at that point. To get to the low end of the gear, add resistance just until the specific gear number shows on the display. For example, if riding at 90 RPM, start adding resistance just until the gear number 8 (or any other desired gear) is displayed. The accuracy of the power displayed will depend on how consistently you can ride at the chosen RPM, and on how where in the gear range you are riding.

Schwinn Echelon2 Power Validation Table										
CARBON BLUE: ON										
ANGLE OFFSET: 0%										
Power Range by Gear										
Gear	RPM									
	60	65	70	75	80	85	90	95	100	105
0	7	8	9	11	12	14	15	17	19	21
	11	12	14	17	19	21	24	27	29	32
1	11	13	15	17	19	21	24	27	30	33
	14	17	20	23	26	29	32	36	40	44
2	15	17	20	23	26	29	33	36	40	44
	18	21	25	29	32	37	41	46	51	56
3	18	22	25	29	33	37	41	46	51	56
	22	26	30	34	39	44	50	55	61	68
4	22	26	30	35	39	44	50	55	61	68
	26	30	35	40	46	52	58	65	72	79
5	26	30	35	41	46	52	58	65	72	79
	30	35	40	46	53	60	67	74	82	91
6	58	67	77	87	97	108	119	130	141	153
	69	80	92	104	116	129	143	156	170	183
7	70	81	92	104	117	130	143	157	170	184
	86	100	114	129	144	160	177	193	210	227
8	86	100	114	129	145	161	177	194	211	228
	107	124	141	160	179	199	219	240	261	282
9	107	124	142	161	180	200	220	241	262	283
	131	151	173	196	219	244	269	294	319	345
10	131	152	174	197	220	245	270	295	321	347
	157	182	209	236	264	294	324	354	385	416
11	158	183	209	237	265	295	325	355	386	417
	186	216	247	279	313	347	383	419	455	492
12	187	216	247	280	314	348	384	420	456	493
	216	251	287	324	363	404	445	487	529	571
13	217	251	287	325	364	405	446	488	530	573
	247	287	328	371	416	462	509	556	605	653
14	248	287	329	372	417	463	510	558	606	655
	279	323	370	418	468	520	573	627	682	737
15	280	324	370	419	470	522	575	629	683	738
	310	360	411	465	521	579	638	698	759	820
16	311	360	412	466	522	580	639	700	760	822
	342	396	453	512	574	637	702	768	835	902

NOTES:

1. Console and power sensor must be properly calibrated with the zero set point tool prior to validate against this chart
2. For purposes of validation, not all gears and RPMs are shown. Only gears 0 - 16 are shown.

**NOTE: The power validation test will work for any gear/RPM combination in the table, so not all combinations need to be used for the validation test.**

<b>Schwinn Echelon2 Power Validation Table</b>											
<b>CARBON BLUE: OFF</b>											
<b>ANGLE OFF SET: 0%</b>											
Power Range by Gear											
Gear	RPM										
	60	65	70	75	80	85	90	95	100	105	110
0	6	7	8	9	11	12	13	15	16	18	20
	9	11	12	14	16	18	21	23	25	28	31
1	9	11	13	14	16	19	21	23	26	28	31
	12	15	17	19	22	25	28	31	35	38	42
2	13	15	17	20	22	25	28	31	35	38	42
	16	19	21	25	28	32	35	40	44	48	53
3	16	19	22	25	28	32	36	40	44	48	53
	19	22	26	30	34	38	43	48	53	58	64
4	19	22	26	30	34	38	43	48	53	59	64
	22	26	30	35	40	45	50	56	62	68	75
5	22	26	31	35	40	45	50	56	62	69	75
	26	30	35	40	46	52	58	64	71	79	86
6	47	55	63	71	79	88	97	106	115	125	134
	57	66	75	85	95	106	116	127	138	150	161
7	57	66	75	85	95	106	117	128	139	150	161
	70	81	93	105	118	131	144	158	172	185	199
8	70	82	93	106	118	131	145	158	172	186	200
	87	101	115	131	146	162	179	196	213	230	247
9	87	101	116	131	147	163	180	197	214	231	248
	107	124	141	160	179	199	219	240	261	282	303
10	107	124	142	161	180	200	220	241	262	283	304
	128	149	170	193	216	240	264	289	314	339	365
11	129	149	171	193	217	241	265	290	315	341	366
	152	176	201	228	255	283	312	342	371	401	431
12	152	177	202	229	256	284	313	343	373	403	433
	177	205	234	265	297	329	363	397	432	466	501
13	177	205	235	265	297	330	364	398	433	468	502
	202	234	268	303	339	377	415	454	494	533	573
14	202	235	268	304	340	378	416	455	495	535	575
	228	264	302	341	382	425	468	512	557	601	646
15	228	264	302	342	383	426	469	513	558	603	648
	253	294	336	380	426	473	521	570	620	669	719
16	254	294	337	381	427	474	522	571	621	671	721
	279	323	369	418	468	520	573	627	682	736	791

NOTES:  
 1. Console and power sensor must be properly calibrated with the zero set point tool prior to validate against this chart  
 2. For purposes of validation, not all gears and RPMs are shown. Only gears 0 - 16 are shown.

**NOTE: The power validation test will work for any gear/RPM combination in the table, so not all combinations need to be used for the validation test.**

**Schwinn Echelon2 Power Validation Table Firmware V1.7 and Later**  
**CARBON BLUE: ON**  
**ANGLE OFFSET: 0%**

**Power Range by Gear**

Gear	RPM										
	60	65	70	75	80	85	90	95	100	105	110
0	11	13	15	18	20	23	25	28	31	35	38
	17	20	24	27	31	35	39	44	48	53	59
1	18	21	24	27	31	35	39	44	49	54	59
	24	28	32	37	42	48	53	59	66	73	80
2	24	28	32	37	42	48	54	60	66	73	80
	30	35	41	47	53	60	67	75	83	92	101
3	30	35	41	47	53	60	68	75	84	92	101
	36	43	49	57	64	73	82	91	101	111	122
4	36	43	49	57	65	73	82	91	101	111	122
	42	50	58	66	76	85	96	107	118	130	143
5	43	50	58	67	76	86	96	107	118	131	143
	49	57	66	76	87	98	110	122	135	149	164
6	64	74	84	95	107	119	131	143	156	168	181
	76	89	101	115	128	143	157	172	187	202	217
7	77	89	102	115	129	143	158	173	188	203	218
	95	110	126	142	159	177	195	213	232	250	269
8	95	110	126	143	160	177	196	214	233	251	270
	118	136	156	176	197	219	242	264	287	310	333

Schwinn Echelon2 Power Validation Table Firmware V1.7 and Later											
CARBON BLUE: OFF											
ANGLE OFFSET: 0%											
Power Range by Gear											
Gear	RPM										
	60	65	70	75	80	85	90	95	100	105	110
0	11	13	15	18	20	23	25	28	31	35	38
	17	20	24	27	31	35	39	44	48	53	59
1	18	21	24	27	31	35	39	44	49	54	59
	24	28	32	37	42	48	53	59	66	73	80
2	24	28	32	37	42	48	54	60	66	73	80
	30	35	41	47	53	60	67	75	83	92	101
3	30	35	41	47	53	60	68	75	84	92	101
	36	43	49	57	64	73	82	91	101	111	122
4	36	43	49	57	65	73	82	91	101	111	122
	42	50	58	66	76	85	96	107	118	130	143
5	43	50	58	67	76	86	96	107	118	131	143
	49	57	66	76	87	98	110	122	135	149	164
6	64	74	84	95	107	119	131	143	156	168	181
	76	89	101	115	128	143	157	172	187	202	217
7	77	89	102	115	129	143	158	173	188	203	218
	95	110	126	142	159	177	195	213	232	250	269
8	95	110	126	143	160	177	196	214	233	251	270
	118	136	156	176	197	219	242	264	287	310	333

### Service Mode

Service mode may be entered immediately after powering on the console, or when the console is in Pause mode (Pause mode is indicated by flashing digits on the screen). Service mode cannot be entered during Ride mode. To enter Service mode, press and hold the "STAGE" button and the "AVG/MAX" button at the same time and hold for 3 seconds. In Service mode, the STAGE button is used to scroll backwards. The LIGHT button is used as an enter button to enter submenus, or make select desired setting. The AVG/MAX button is used to scroll forward. To exit the Service mode, scroll to the EXIT menu and press the LIGHT (Enter) button.

## Service Menu Maps

### Ride, Sport, Average, and Max Modes

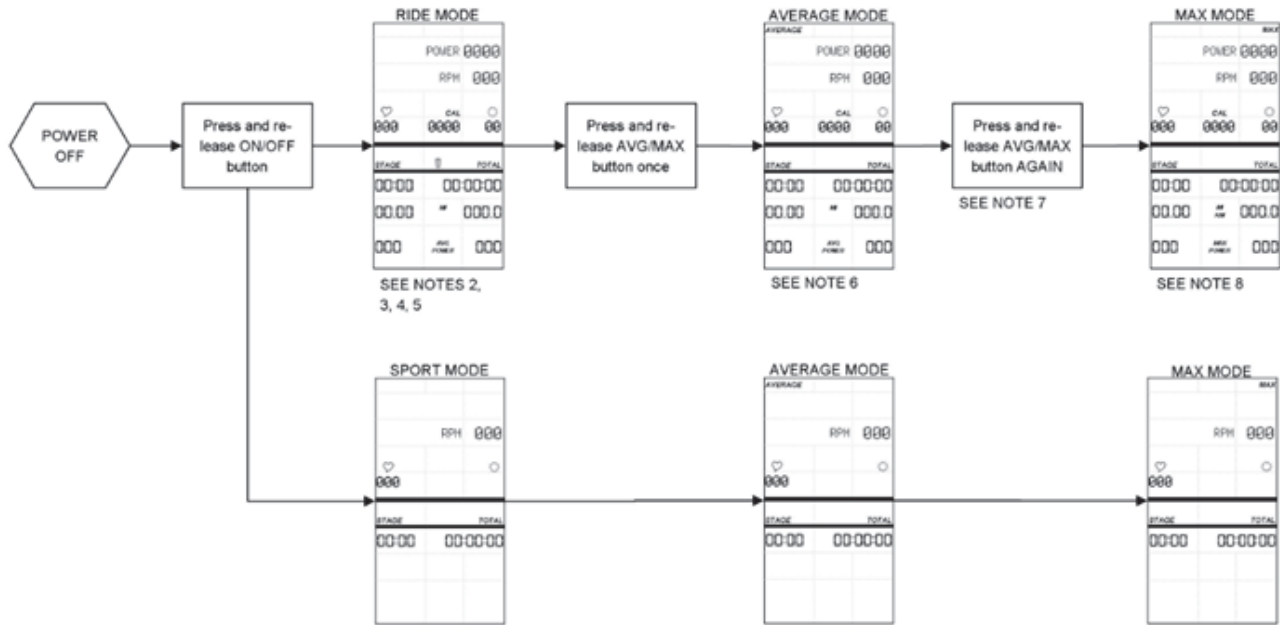

### Stage Mode

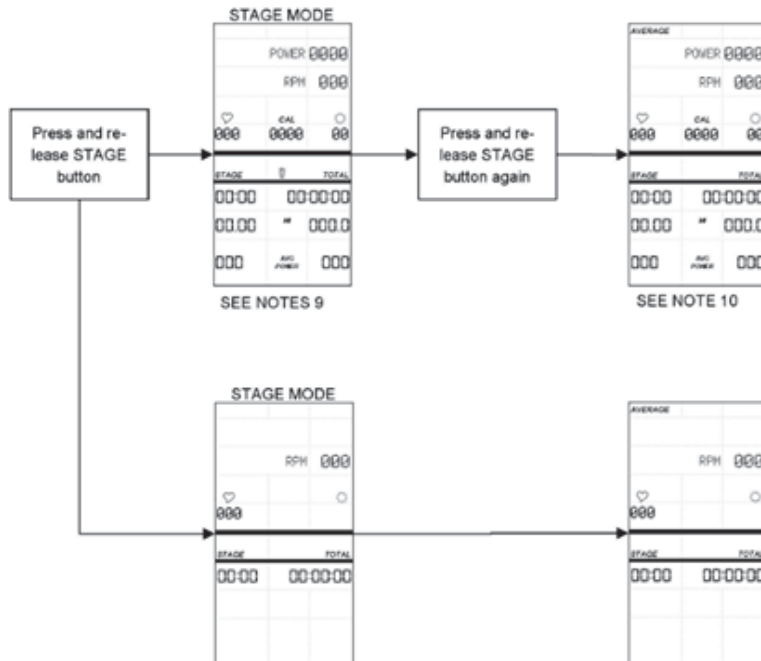

## Pause and Summary Modes

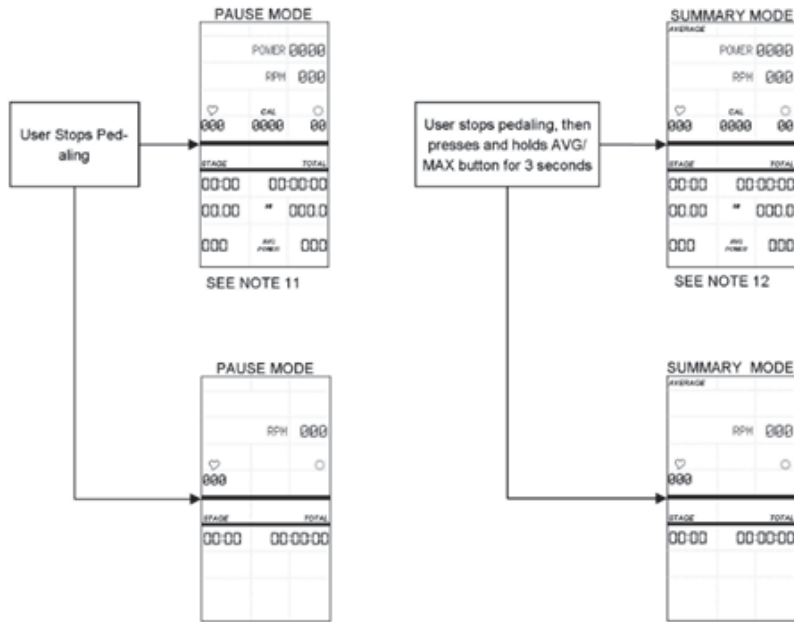

## Service Menu

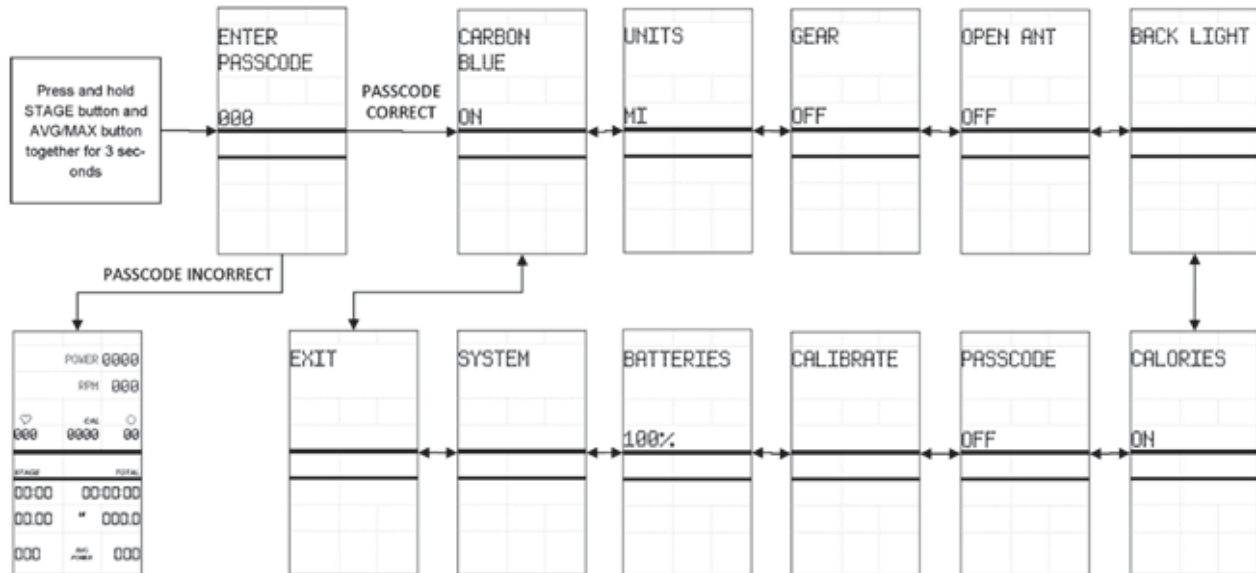

## Schwinn MPower Echelon2 Key Flow Diagrams

### Service Menu—Carbon Blue, Units, Gear, Open Ant, and Calories Settings

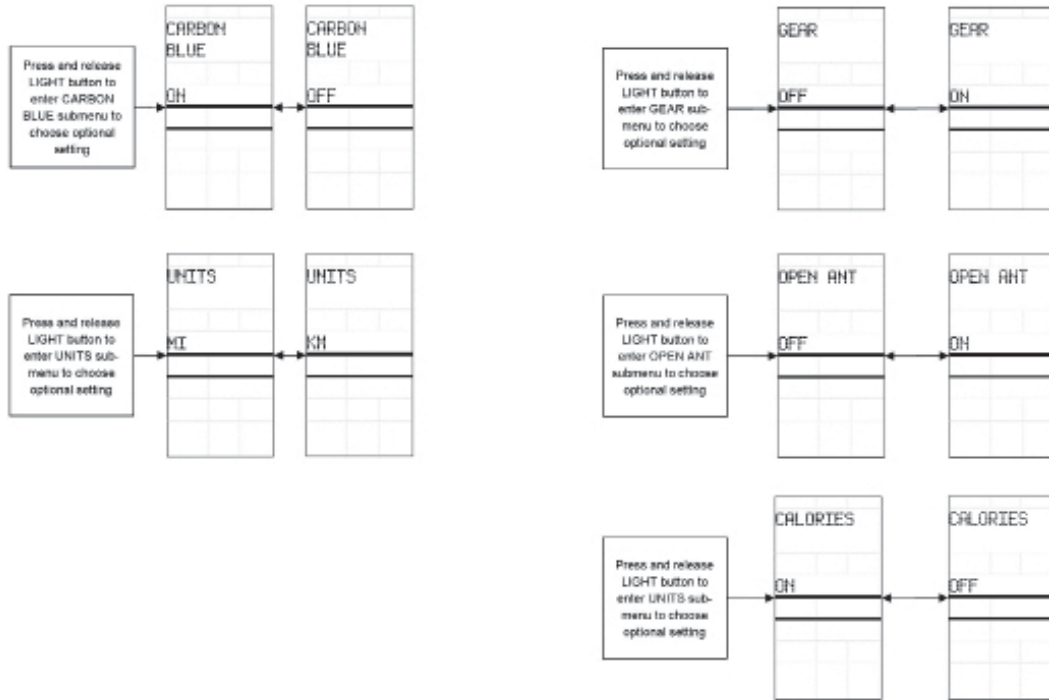

### Service Menu—Backlight Setting

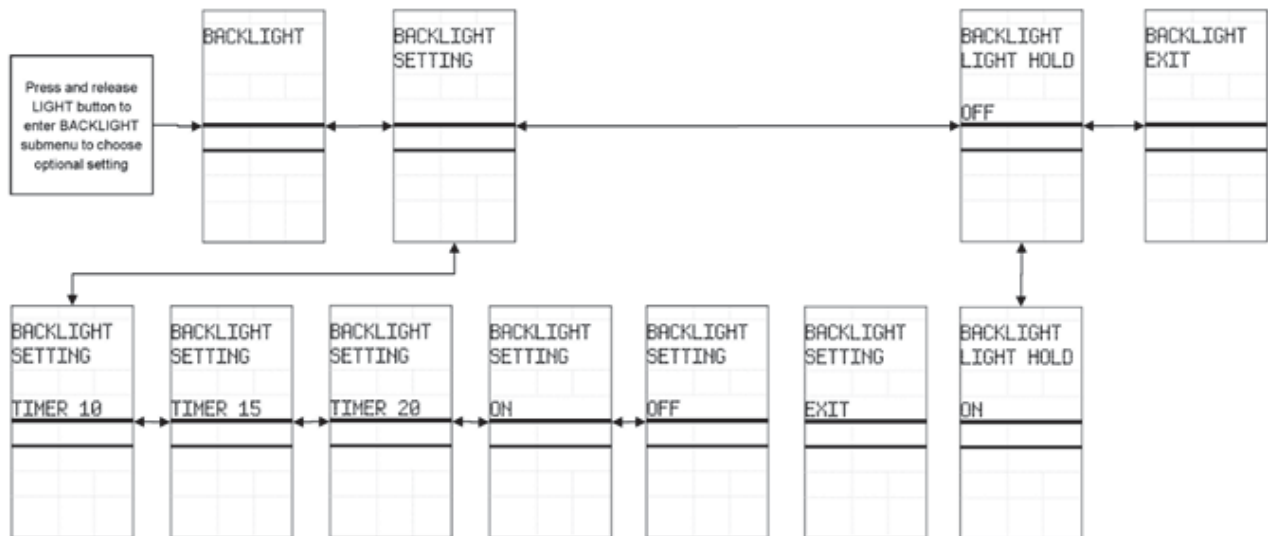



### Service Menu—Passcode Setting

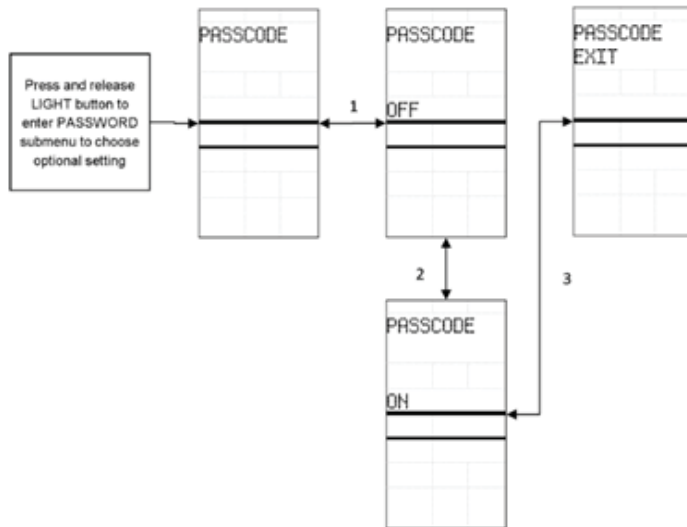

### Service menu – Calibrate Menu

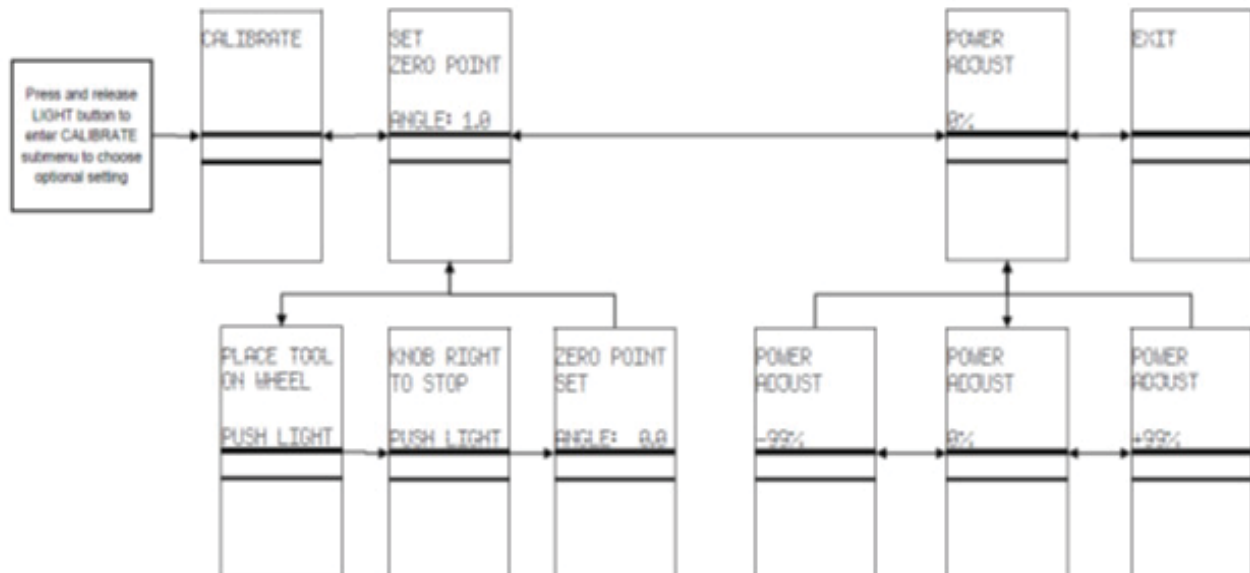

### Service Menu

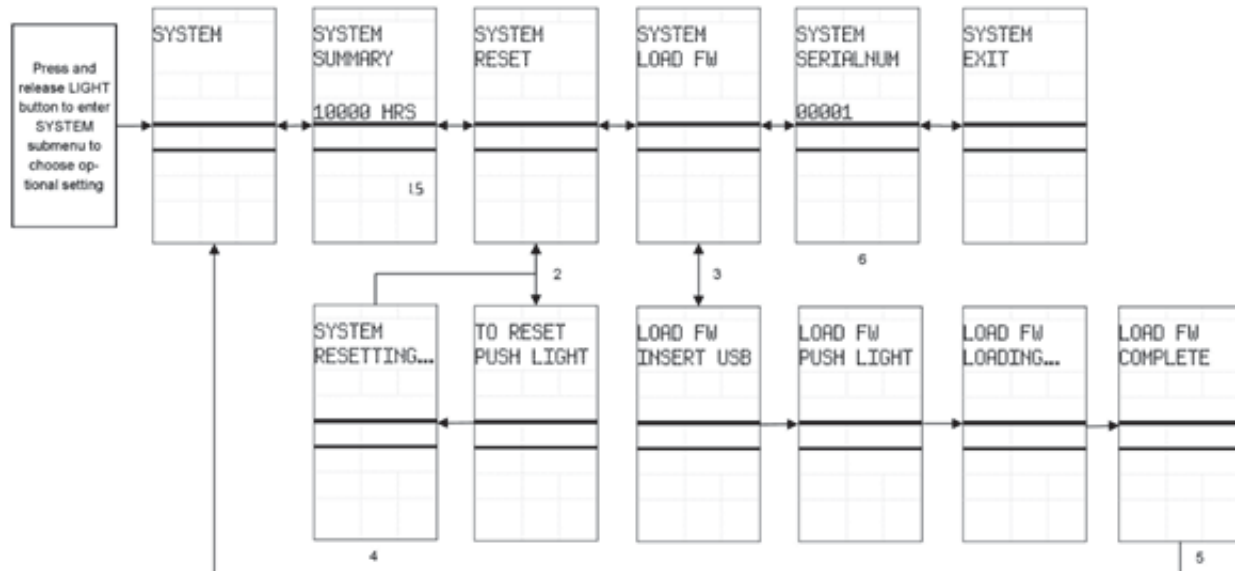

### Schwinn MPower Echelon2 Key Flow Diagrams Quick Zero Point Check

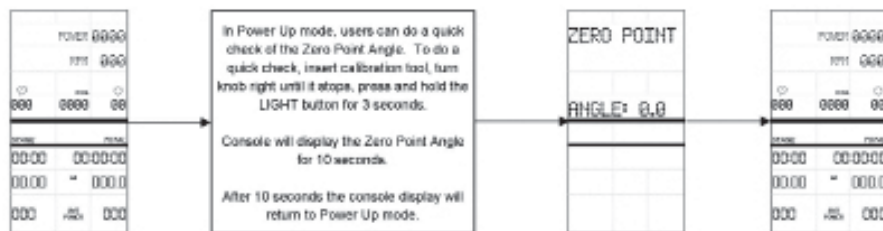

## System Settings Defined

### **Carbon Blue**

This setting is used to distinguish between Carbon Blue bike with a belt and bikes with a chain. The default setting is ON. Leave this setting set to ON for Carbon Blue models. On models with chain, set it to OFF.

### **Gear**

This is an optional setting that enables the console to display a gear number that corresponds to the level of resistance. When set to ON, a gear symbol and gear number will be displayed on the right side of the console next to the calories value. This setting is set to OFF by default.

### **Units**

The units refer to the distance. The two optional settings are miles or kilometers. The default setting is miles.

### **Open Ant Channel**

This setting is used to turn on the channel that broadcasts data to external leaderboard systems that display console data on a large screen. This must be set to ON in order for external systems to read data from the console. It is set to OFF by default. Leaving this setting off when not used conserves battery life.

### **Backlight**

This setting allows the user to set the backlight display to a number of settings. In the BACKLIGHT SETTING submenu the backlight can be set as follows:

- Backlight displays for 10 seconds when the LIGHT button is pressed in Ride mode (this is the default setting).
- Backlight displays for 15 seconds when the LIGHT button is pressed in Ride mode.
- Backlight displays for 20 seconds when the light button is pressed in Ride mode.
- When set to ON, the backlight will always be on when the console is on.
- When set to OFF, the backlight cannot be used when the console is on.

In the BACKLIGHT HOLD submenu the backlight display can be set as follows:

- When set to ON, the rider can press and hold the LIGHT button for 5 seconds, allowing the backlight to remain on until the rider presses the LIGHT button again to turn off the light.
- When set to OFF, the backlight hold display cannot be used.

### **Calories**

This is an optional setting that enables the user to turn the calorie (CAL) display ON or OFF. This setting is set to ON by default. NOTE: This optional setting is not available in firmware version V1.0. It is available only in firmware version V1.1 and later.

### **Batteries**

The battery strength is displayed on the BATTERIES screen.

## Preventative Maintenance

### Before every ride:

- Check to ensure no wires are damaged or disconnected.
- Check to ensure all wires are secure and not touching any moving part of the bike.

### After every ride:

- Wipe down the console.
- Power down console to conserve battery life.

### Each week

- Inspect all screws and hardware securing console and wires to bike, ensuring they are tight.

### Each month

- Check to ensure console is properly calibrated and [perform the Zeropoint calibration if needed](#).

## Wiring Diagrams

### Echelon2 with RPM Sensor ONLY

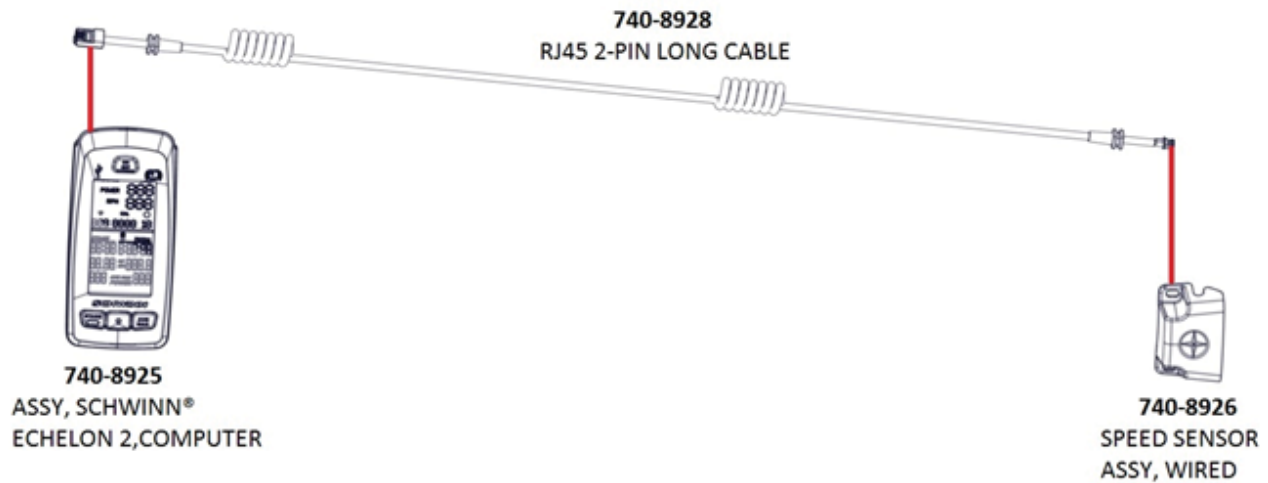

### Echelon2 with RPM Sensor AND Power Sensor:

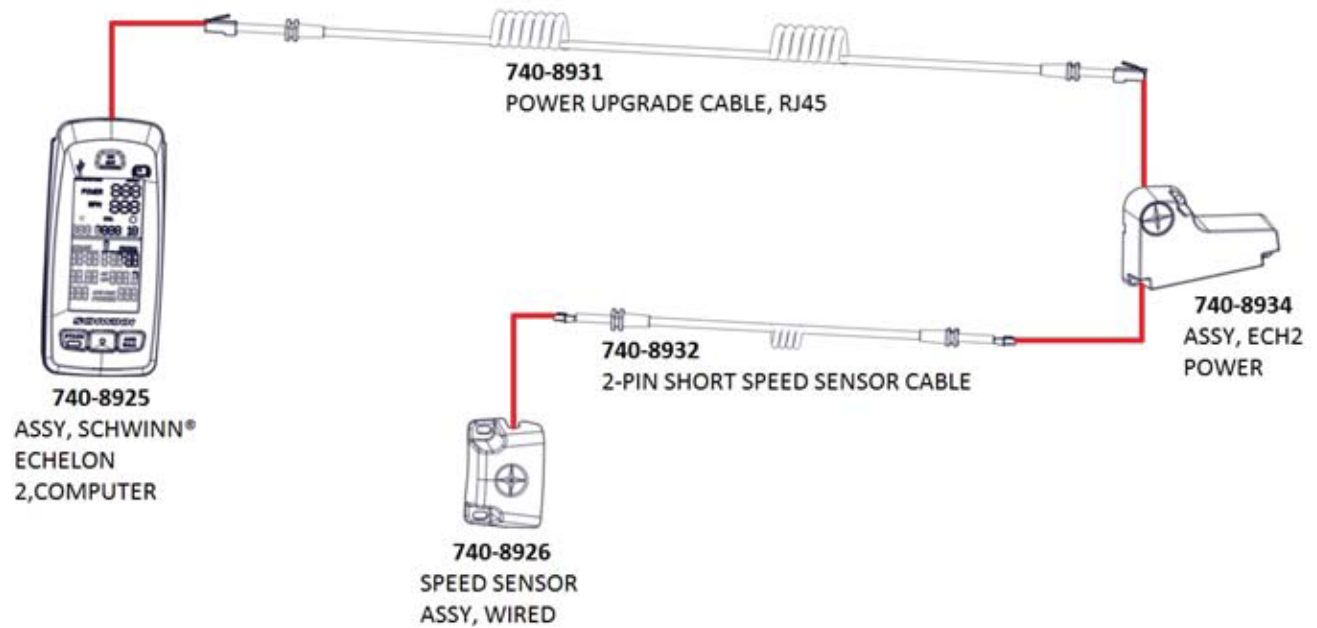

## Troubleshooting

- RPM Troubleshooting
- Leaderboard not Connecting
- No Power to Console
- Device Pairing
- No Power or Calorie Reading
- Readings Inconsistent



## RPM Troubleshooting

Echelon & Echelon 2

Doc. #637-4419

The purpose of the document is to help troubleshoot for intermittent or no RPM readings on the Echelon 2 console.

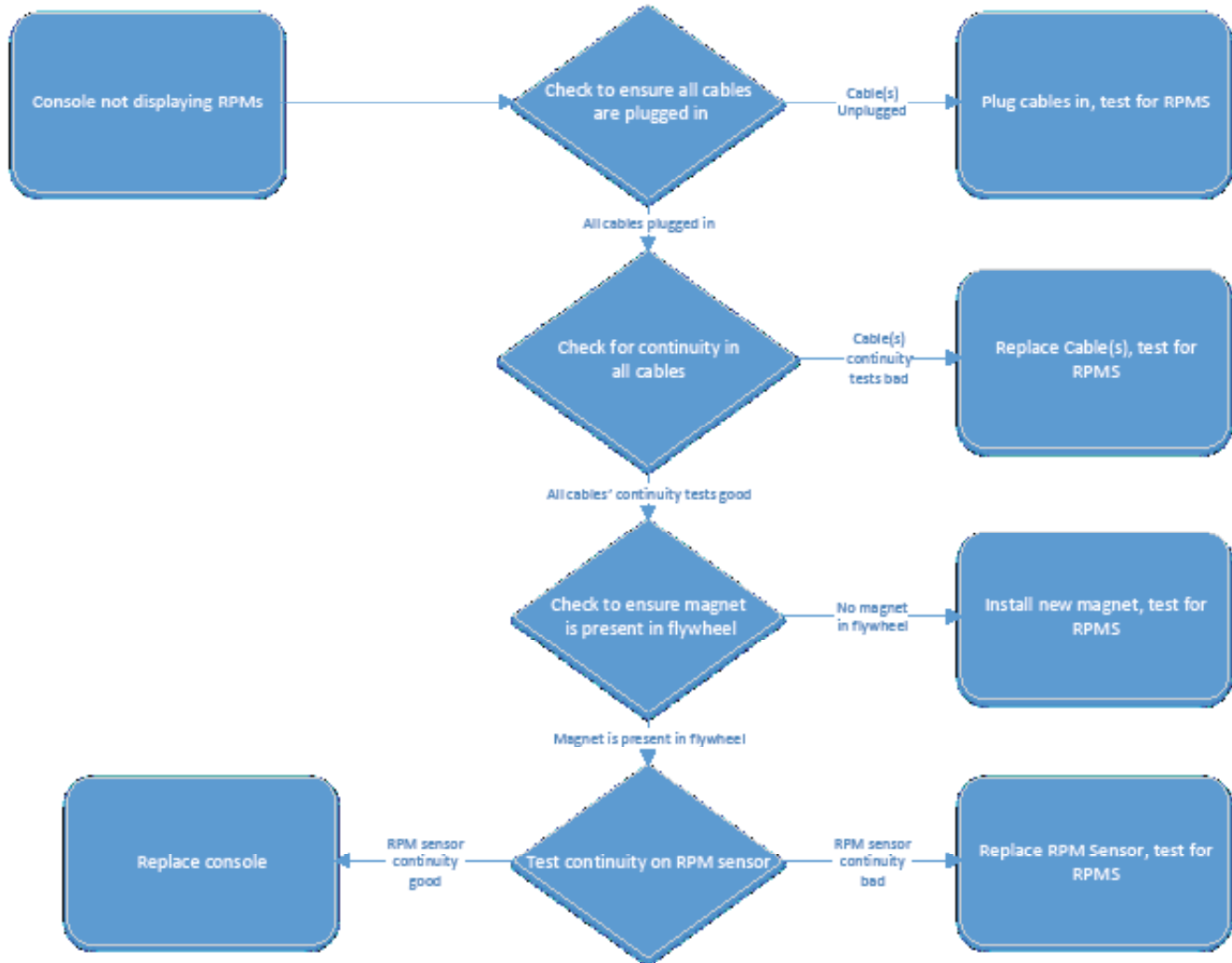

- Checking for magnet in flywheel:

Use a steel paperclip and run it around the inside of the flywheel about 1 inch away from the edge of the Schwinn Star decal. As shown below, if the magnet is present, the steel paperclip should stick.





- Testing continuity on the RPM sensor:

Tools Required:

- Multimeter
- Phillips Screwdriver

- Remove the RPM sensor from the bike using a phillips screwdriver then use a multimeter to check the continuity on the RPM sensor (Fig. 1) while waving a magnet ~1-2mm from the front of the sensor (Fig. 2).



Fig 1.

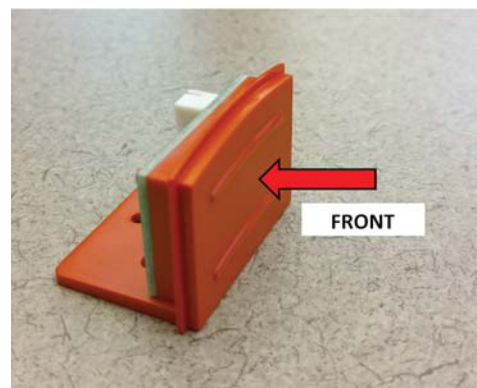

Fig. 2

- As the magnet passes in front of the sensor, if the sensor is working correctly, the multimeter should beep, confirming continuity.

**NOTE: The decals may not be in the same position on the flywheel itself so the actual location of the magnet in relation to the decals may be different.**



## Not Connecting to Leaderboard System

Echelon & Echelon 2

Doc. #637-4456

The purpose of this document is to help troubleshoot connectivity issues when pairing the Echelon 2 console to a leaderboard system such as Performance IQ (PIQ).

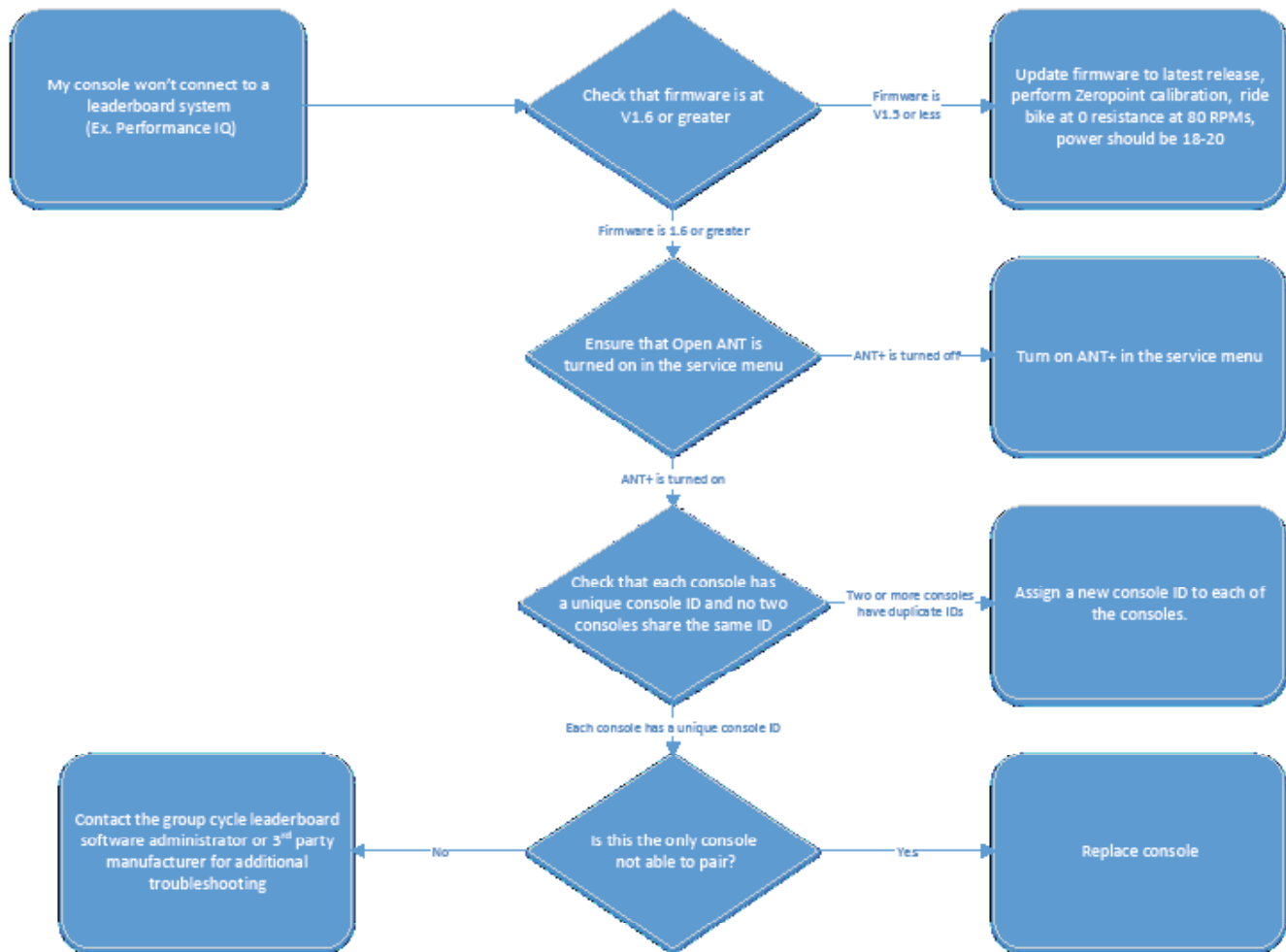

### Checking current firmware version:

6. Press the ON/OFF button at the top of the display
7. Push and hold the STAGE and AVG/MAX buttons at the same time until “Carbon Blue” appears on the display, this is the landing screen for the service menu.
8. Press the AVG/MAX button to scroll through the service menu until “SYSTEM” is displayed, then press the light button to enter the SYSTEM menu.
9. The current firmware version will be displayed in the lower right corner of the display.

### Updating firmware:

The Echelon 2 software will need to be transferred to a USB drive formatted for FAT32, as our console uses a FAT32 compatible USB drive. Any USB drive can be reformatted to use the FAT32 file system from a computer. To reformat a USB stick on a Windows computer, do the following:

1. Right click on the USB stick name in Windows Explorer.
2. Click on the FORMAT menu option.
3. In the FORMAT menu, click on the FILE SYSTEM pull-down menu.
4. In the FILE SYSTEM pull-down menu, choose FAT32. All data on the USB stick will be deleted and the drive will now use the FAT32 system and should work with the console.
5. Transfer the newest software onto the newly formatted USB stick for use in updating the console.
6. When the firmware file is loaded on the USB stick, it needs to be renamed “MPowerQ.bin”.

NOTE: If updating from V1.1 firmware, do not include the Echelon2ID.txt file with the firmware, as it will reset console IDs that were previously set with V1.1.

### Updating the Echelon 2 software:

1. Turn on the console by pressing ON/OFF button, then press and hold AVE/MAX & STAGE buttons simultaneously for 5 seconds. This will get you into the Service Mode.
2. Press STAGE button until SYSTEM appears on the screen. Then press the LIGHT to enter the SYSTEM menu.
3. Press STAGE button until LOAD FW command appears, then press the LIGHT button.
4. INSERT USB command will appear, insert the USB into port at the top of the console.
5. Press the LIGHT button again and this will activate the loading process. This may take up to a minute to complete. If it does not finish after one minute, there may be an issue with the files (location on drive) or the USB. Remove the USB stick, power cycle the console, and try the update again from step 1. If the update still does not work, there may be an issue with the USB drive and/or files.
6. When uploading the firmware, an error message (“WR ANTID” and “WRID ERR1”) will pop up three times while the firmware is loading. This is ok. It just means that the firmware is looking for the ID file. After the third attempt to find the file, it bypasses the ID rewriting step and loads the firmware.
7. Once loading is complete. The system will notify it has completed with “LOAD FW COMPLETE” message.

NOTE: After updating the Echelon2 firmware, please be sure to perform the Zeropoint calibration procedure.

### Turning on Open ANT:

1. With the console powered on, hold the STAGE and AVG/MAX buttons at the same time for about 5-10 seconds to enter the service menu.
2. Once in the service menu, use the AVG/MAX button to scroll until “OPEN ANT” is displayed at the top of the screen.
3. Push the LIGHT button to select Open ANT, push AVG/MAX until “ON” is displayed, then push the LIGHT button again to select ON.
4. Once finished, use the AVG/MAX button to scroll until “EXIT” is displayed at the top of the screen, then push the LIGHT button to exit the service menu.

**Checking ID number:**

1. Enter Service Mode again by pressing and holding the STAGE and AVG/MAX buttons.
2. Scroll to the "SYSTEM" menu by pressing the AVG/MAX button. Then press the LIGHT button to enter the system sub-menu.
3. Press the AVG/MAX button to scroll in the system sub-menu until "SERIALNUM" is displayed. The number displayed below "SERIALNUM" is the console ID.

**Changing ID number:**

1. Enter Service Mode again by pressing and holding the STAGE and AVG/MAX buttons.
2. Scroll to the "SYSTEM" menu by pressing the AVG/MAX button. Then press the LIGHT button to enter the system sub-menu.
3. Press the AVG/MAX button to scroll in the system sub-menu until "SERIALNUM" is displayed.
4. Push and hold the STAGE and AVG/MAX buttons at the same time until a new ID number is assigned.



## No Power to Console

Echelon & Echelon2

Doc. #637-4454

This purpose of this document is to help troubleshoot and diagnose for power issues on the Echelon 2 console.

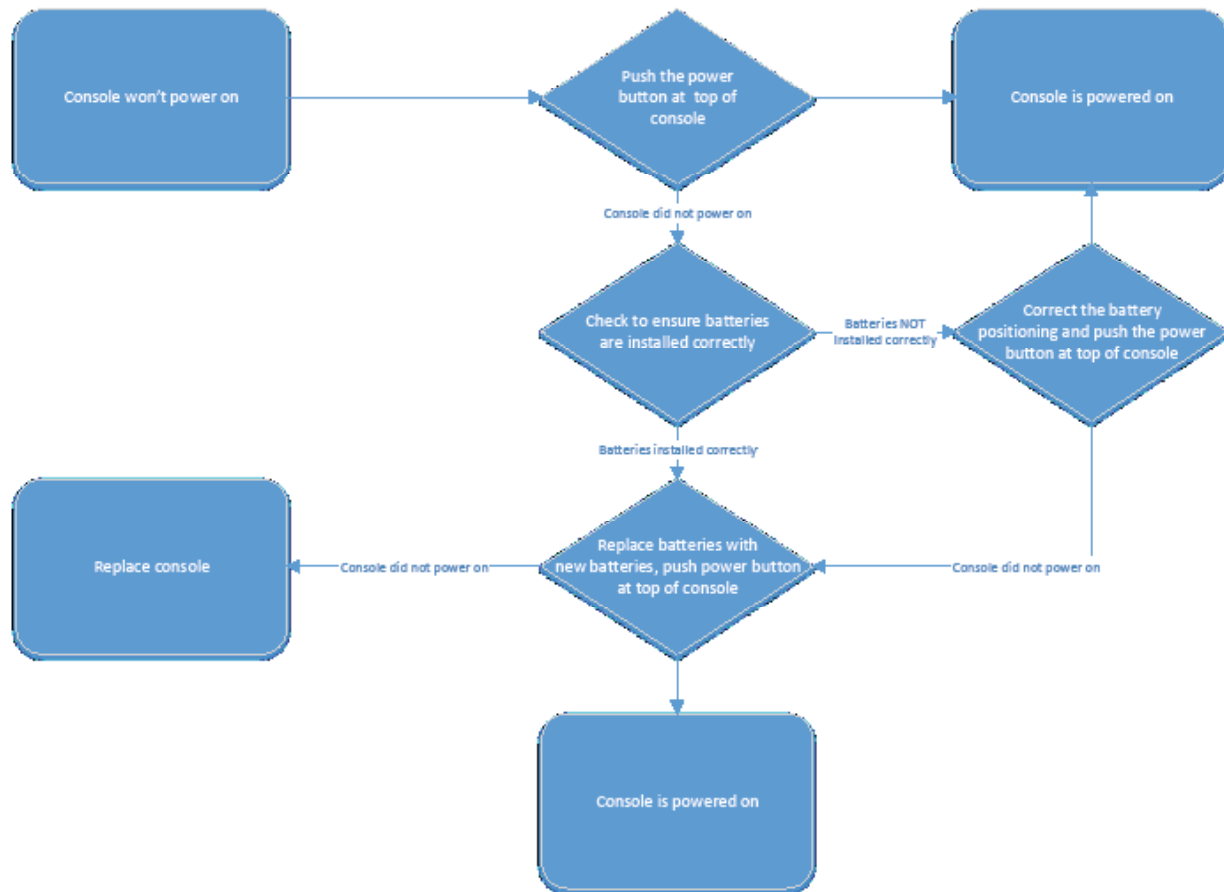

Power Button



Correct Battery Orientation



## Heartrate or Fitness Tracker Not Pairing

Echelon 2

Doc. #637-4455

The purpose of this document is to help troubleshoot for heartrate monitors or fitness trackers not pairing to the Echelon 2 console.

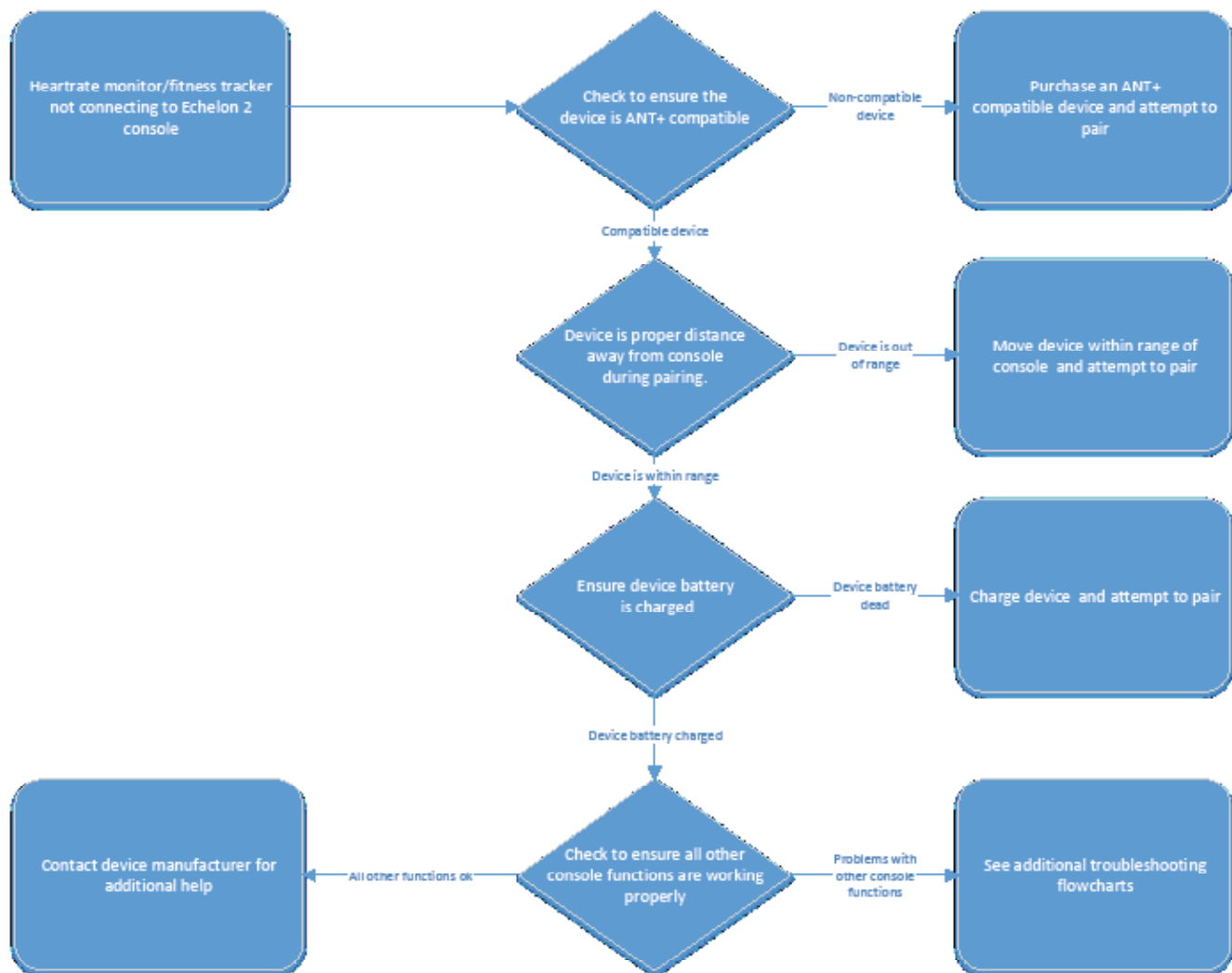

- To check if the device that is attempting to be paired is compatible with the Echelon 2, please visit [www.thisisant.com/directory/mpower-echelon2-cosole/](http://www.thisisant.com/directory/mpower-echelon2-cosole/)
- Device pairing distances:

ANT+  
Watch



HRM



- ANT+ watch --link to the console. Move the watch to 2"-4" (5-10 cm) or less from the ANT+ Link Here icon on the console and hold it there until proximity linking is complete.

- ANT+ HRM --link to the console. Lean into the console so that the HRM is 7.5"-31" (20-80 cm) from the ANT+ Link Here logo, until a value is displayed.



## No Power or Calorie Reading

Echelon 2

Doc. #637-4457

The purpose of this document is to help troubleshoot when no power or calorie readings are displayed on the Echelon 2 console. **Please note that the power sensor is required in order for the console to display power or calories.**

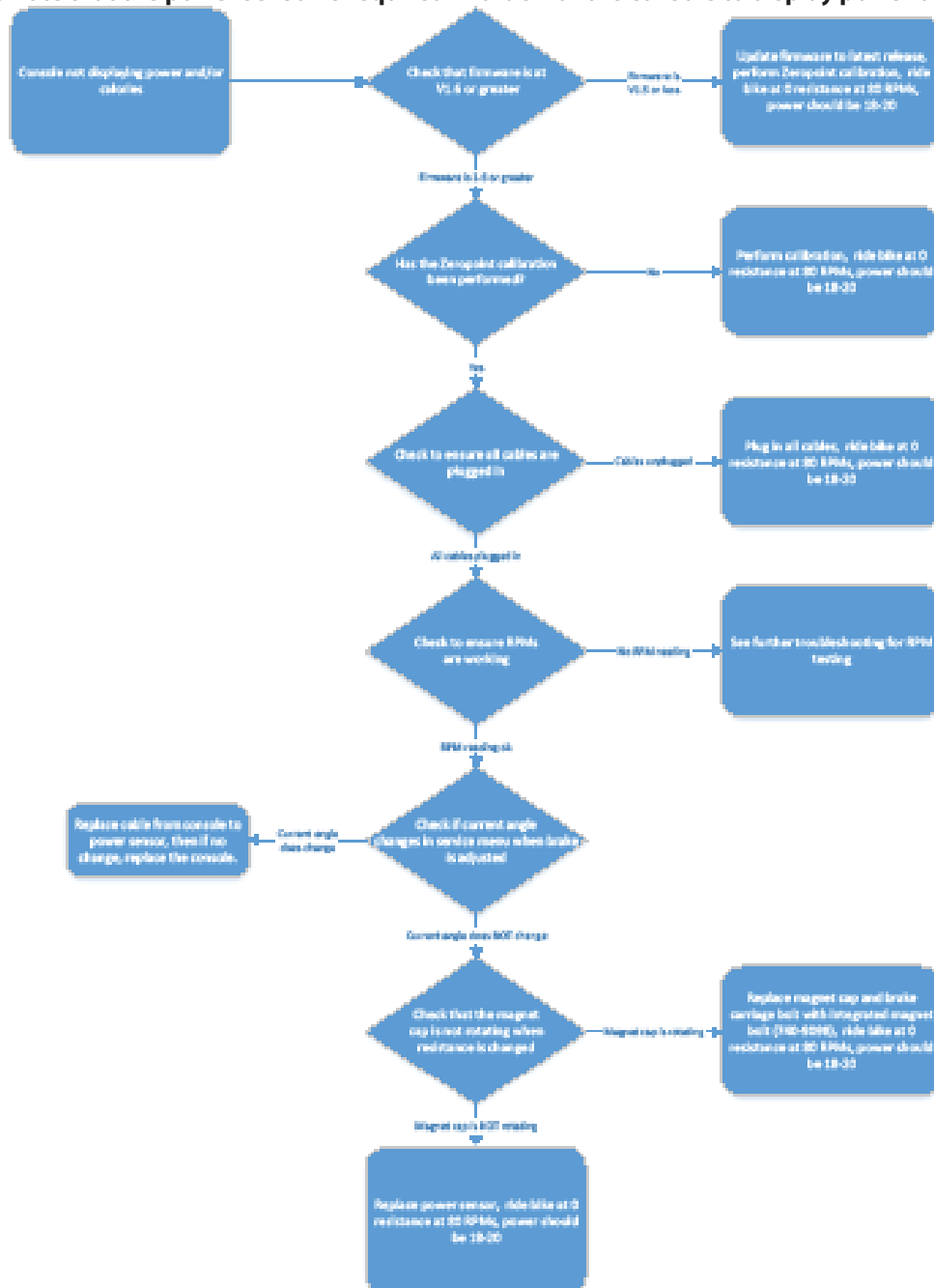



### Checking current firmware version:

5. Press the ON/OFF button at the top of the display
6. Push and hold the STAGE and AVG/MAX buttons at the same time until “Carbon Blue” appears on the display, this is the landing screen for the service menu.
7. Press the AVG/MAX button to scroll through the service menu until “SYSTEM” is displayed, then press the light button to enter the SYSTEM menu.
8. The current firmware version will be displayed in the lower right corner of the display.

### Updating firmware:

The Echelon 2 software will need to be transferred to a USB drive formatted for FAT32, as our console uses a FAT32 compatible USB drive. Any USB drive can be reformatted to use the FAT32 file system from a computer.

To reformat a USB stick on a Windows computer, do the following:

1. Right click on the USB stick name in Windows Explorer.
2. Click on the FORMAT menu option.
3. In the FORMAT menu, click on the FILE SYSTEM pull-down menu.
4. In the FILE SYSTEM pull-down menu, choose FAT32. All data on the USB stick will be deleted and the drive will now use the FAT32 system and should work with the console.
5. Transfer the newest software onto the newly formatted USB stick for use in updating the console.
6. When the firmware file is loaded on the USB stick, it needs to be renamed “MPowerQ.bin”.

**NOTE: If updating from V1.1 firmware, do not include the Echelon2ID.txt file with the firmware, as it will reset console IDs that were previously set with V1.1.**

### Updating the Echelon 2 software:

1. Turn on the console by pressing ON/OFF button, then press and hold AVE/MAX & STAGE buttons simultaneously for 5 seconds. This will get you into the Service Mode.
2. Press STAGE button until SYSTEM appears on the screen. Then press the LIGHT to enter the SYSTEM menu.
3. Press STAGE button until LOAD FW command appears, then press the LIGHT button.
4. INSERT USB command will appear, insert the USB into port at the top of the console.
5. Press the LIGHT button again and this will activate the loading process. This may take up to a minute to complete. If it does not finish after one minute, there may be an issue with the files (location on drive) or the USB. Remove the USB stick, power cycle the console, and try the update again from step 1. If the update still does not work, there may be an issue with the USB drive and/or files.
6. When uploading the firmware, an error message (“WR ANTID” and “WRID ERR1”) will pop up three times while the firmware is loading. This is ok. It just means that the firmware is looking for the ID file. After the third attempt to find the file, it bypasses the ID rewriting step and loads the firmware.
7. Once loading is complete. The system will notify it has completed with “LOAD FW COMPLETE” message.

**NOTE: After updating the Echelon2 firmware, please be sure to perform the Zeropoint calibration procedure.**

### Performing Zeropoint calibration:

1. Power on the console



2. Enter the service menu by holding down the STAGE and AVG/MAX buttons together for about 4-6 seconds.

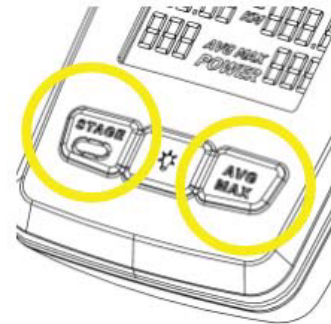

3. Once in the service menu, use the AVG/MAX button to scroll to the CALBRATE menu. Press and release the LIGHT button to enter the menu



4. Scroll to CALIBRATE ZEROPOINT option and press the LIGHT button.



5. Follow the on-screen instructions; place the calibration tool on the flywheel, rotate back until the tool fits between the magnets of the brake assembly, and then press the LIGHT button.

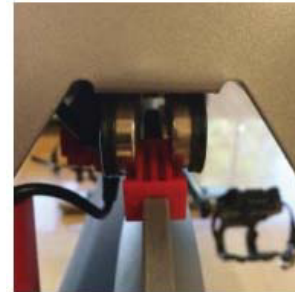

6. Turn the brake knob clockwise until the brake mechanism makes contact with the calibration tool and press the LIGHT button.

**Do not over tighten.**



7. The console will display that the Zeropoint is now set. Press the LIGHT button to exit CALIBRATE ZEROPOINT.



8. Once the calibration passes, go to CALIBRATE CURRENT ANGLE and verify the angle is 0.0 (+/- 0.1 degrees)

Occasionally, the calibration process does not correctly set the angle on the first try. If the angle reads anything other than 0.0 (+/- 0.1 degrees), perform the calibration again until the CURRENT ANGLE reads 0.0 (+/- 0.1 degrees).

Note: The sensor measures in degrees, so 0.0 – 0.1 = 359.9.



9. At this point calibration is done. Exit the service menu and remove the tool from the flywheel (keep for future use, the tool can be stored under the cosmetic bracket cover for safe keeping)



#### Checking current angle:

1. With the console powered on, hold the STAGE and AVG/MAX buttons at the same time for about 5-10 seconds to enter the service menu.
2. Once in the service menu, use the AVG/MAX button to scroll until "CALIBRATE" is displayed at the top of the screen, then press the LIGHT button to enter the calibration sub-menu.
3. Use the AVG/MAX button to scroll until "CURRENT ANGLE" is displayed. The number on that screen is the current angle of the power sensor relative to the zero point.

**Checking to see if magnet cap is rotating:**

1. Remove the use right side sweat guard using a phillips screwdriver.
2. Remove the power sensor using a 3/32" allen key.
3. Attempt to turn the magnet cap located over the nut of the main brake carriage bolt as shown below.

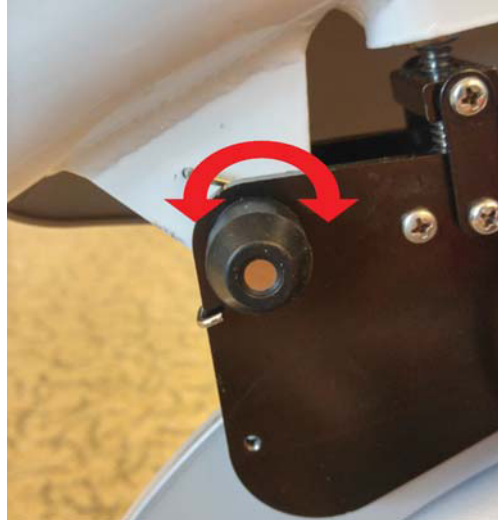

4. If magnet cap is rotating and 740-9098 "F-Screw ASSY, W-Magnet, M10 Shoulder, AC Bike Brake" must be installed:

- a. Use a phillips screwdriver to remove the three (3) screws securing the user left side sweat guard to the frame of the bike. Repeat this step for the user right side sweat guard.

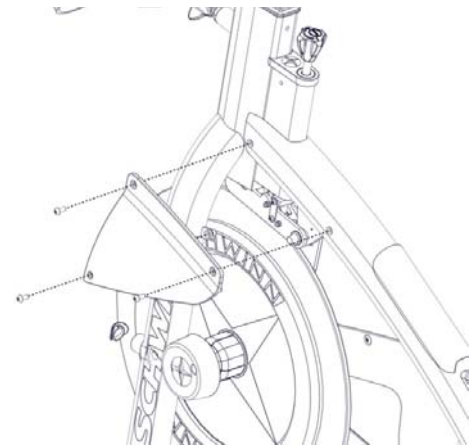

- b. Using a 8mm allen key and a 17mm socket, remove the hardware that secures the brake assembly to the frame

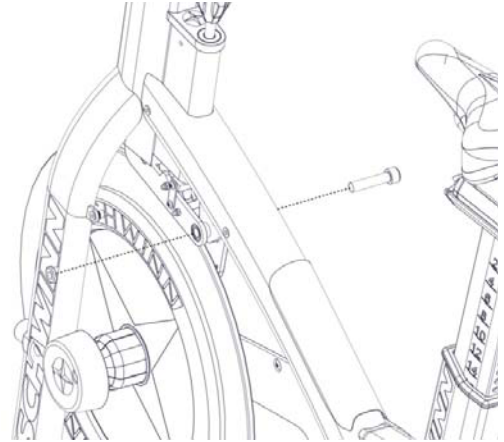

- c. Insert the bolt component of 740-9098 from the user right hand side to re-secure the brake assembly to the frame. Note that you may need to loosen the set screw inside the bolt using a 2mm allen key in order to insert the bolt into the brake and/or frame. Once the brake assembly has been secured to the frame via the bolt, use a 2mm allen key to tighten the set screw. Once the set screw is tight, use a crescent wrench to hold the bolt from the user right side and tighten the nut onto the bolt using a 17mm socket from the user left.

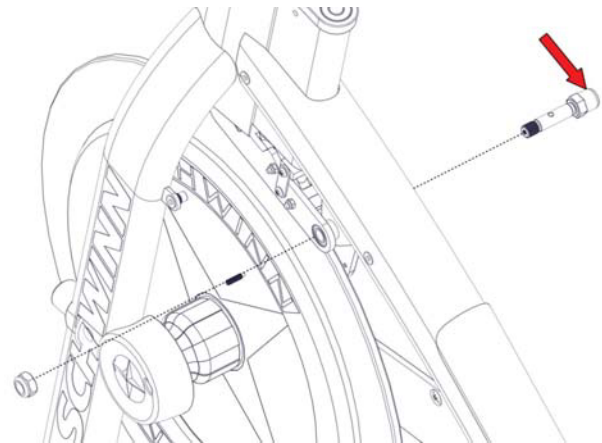



## Power or Calorie Readings High/Low/Inconsistent

Echelon 2

Doc. #637-4458

The purpose of the document is to help troubleshoot low/high/inconsistent power or calorie readings on the Echelon 2 console.

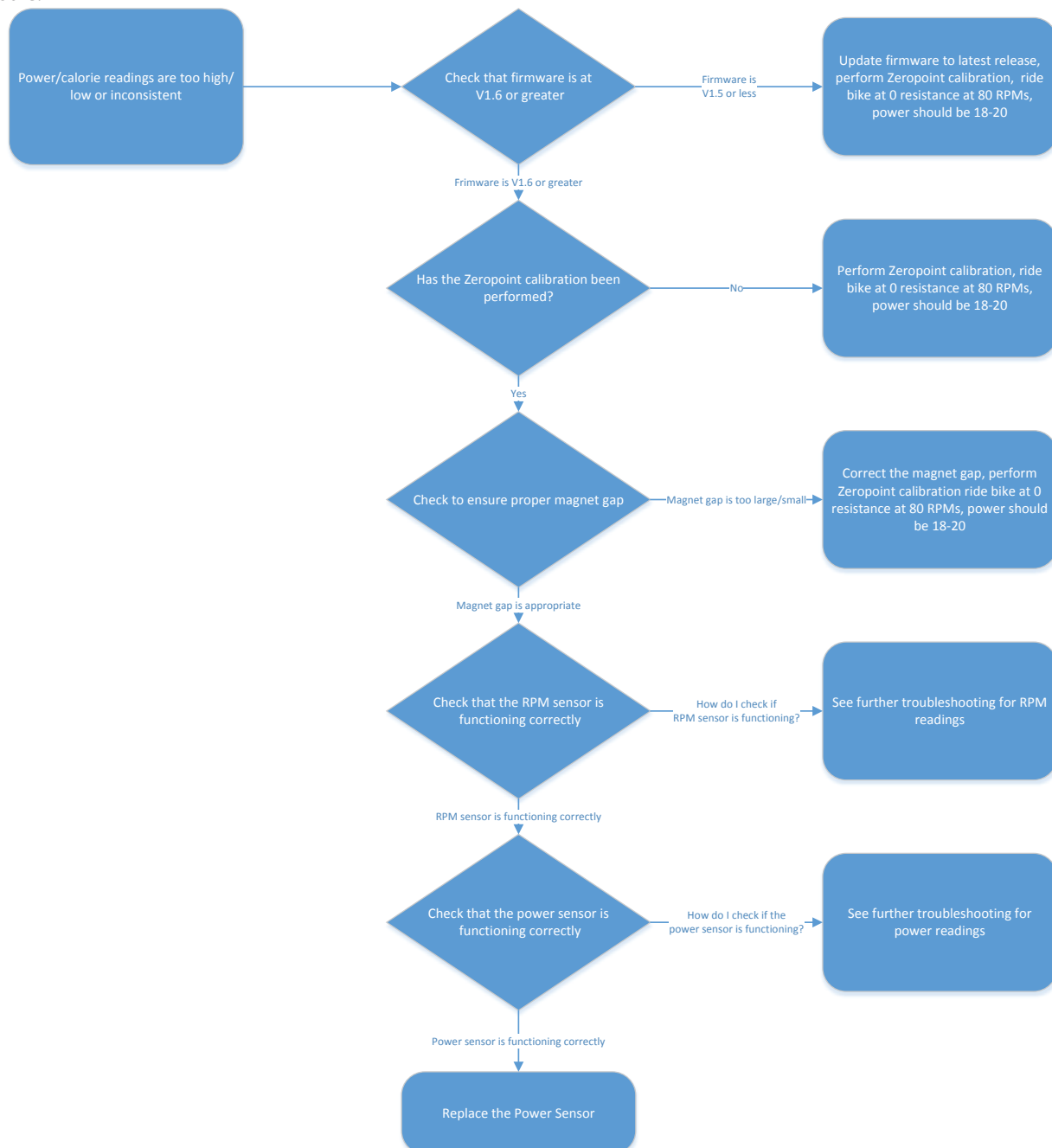

### Checking current firmware version:

5. Press the ON/OFF button at the top of the display
6. Push and hold the STAGE and AVG/MAX buttons at the same time until “Carbon Blue” appears on the display, this is the landing screen for the service menu.
7. Press the AVG/MAX button to scroll through the service menu until “SYSTEM” is displayed, then press the light button to enter the SYSTEM menu.
8. The current firmware version will be displayed in the lower right corner of the display.

### Updating firmware:

The Echelon 2 software will need to be transferred to a USB drive formatted for FAT32, as our console uses a FAT32 compatible USB drive. Any USB drive can be reformatted to use the FAT32 file system from a computer.

To reformat a USB stick on a Windows computer, do the following:

1. Right click on the USB stick name in Windows Explorer.
2. Click on the FORMAT menu option.
3. In the FORMAT menu, click on the FILE SYSTEM pull-down menu.
4. In the FILE SYSTEM pull-down menu, choose FAT32. All data on the USB stick will be deleted and the drive will now use the FAT32 system and should work with the console.
5. Transfer the newest software onto the newly formatted USB stick for use in updating the console.
6. When the firmware file is loaded on the USB stick, it needs to be renamed “MPowerQ.bin”.

**NOTE: If updating from V1.1 firmware, do not include the Echelon2ID.txt file with the firmware, as it will reset console IDs that were previously set with V1.1.**

### Updating the Echelon 2 software:

1. Turn on the console by pressing ON/OFF button, then press and hold AVE/MAX & STAGE buttons simultaneously for 5 seconds. This will get you into the Service Mode.
2. Press STAGE button until SYSTEM appears on the screen. Then press the LIGHT to enter the SYSTEM menu.
3. Press STAGE button until LOAD FW command appears, then press the LIGHT button.
4. INSERT USB command will appear, insert the USB into port at the top of the console.
5. Press the LIGHT button again and this will activate the loading process. This may take up to a minute to complete. If it does not finish after one minute, there may be an issue with the files (location on drive) or the USB. Remove the USB stick, power cycle the console, and try the update again from step 1. If the update still does not work, there may be an issue with the USB drive and/or files.
6. When uploading the firmware, an error message (“WR ANTID” and “WRID ERR1”) will pop up three times while the firmware is loading. This is ok. It just means that the firmware is looking for the ID file. After the third attempt to find the file, it bypasses the ID rewriting step and loads the firmware.
7. Once loading is complete. The system will notify it has completed with “LOAD FW COMPLETE” message.

**NOTE: After updating the Echelon2 firmware, please be sure to perform the Zeropoint calibration procedure.**



### Performing Zeropoint calibration:

1. Power on the console



2. Enter the service menu by holding down the STAGE and AVG/MAX buttons together for about 4-6 seconds.

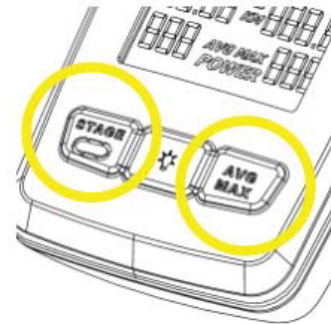

3. Once in the service menu, use the AVG/MAX button to scroll to the CALBRATE menu. Press and release the LIGHT button to enter the menu



4. Scroll to CALIBRATE ZEROPOINT option and press the LIGHT button.



5. Follow the on-screen instructions; place the calibration tool on the flywheel, rotate back until the tool fits between the magnets of the brake assembly, and then press the LIGHT button.

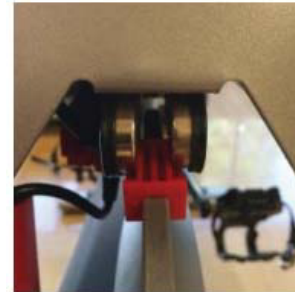

6. Turn the brake knob clockwise until the brake mechanism makes contact with the calibration tool and press the LIGHT button.

**Do not over tighten.**



7. The console will display that the Zeropoint is now set. Press the LIGHT button to exit CALIBRATE ZEROPOINT.



8. Once the calibration passes, go to CALIBRATE CURRENT ANGLE and verify the angle is 0.0 (+/- 0.1 degrees)

Occasionally, the calibration process does not correctly set the angle on the first try. If the angle reads anything other than 0.0 (+/- 0.1 degrees), perform the calibration again until the CURRENT ANGLE reads 0.0 (+/- 0.1 degrees).

Note: The sensor measures in degrees, so 0.0 – 0.1 = 359.9.



9. At this point calibration is done. Exit the service menu and remove the tool from the flywheel (keep for future use, the tool can be stored under the cosmetic bracket cover for safe keeping)



### Checking magnet gap:

In order to achieve consistent power output between multiple bikes, it is very important that the gap between the magnets on the resistance mechanism is correct and consistent between bikes. The gap is set by the factory when the bikes are assembled; however, some older model bikes may not have correct magnet gap. Checking the magnet gap and adjusting it as needed, will ensure a high level of consistency of power output between bikes.

1. The two pictures below show the resistance mechanism with a correct magnet gap and with an incorrect (too large) magnet gap. The tool used to measure magnet gap is the same tool that is used to calibrate the power sensor on each bike. The left shows the correct gap when checked with the tool. The right picture shows a gap that is too large. The calibration tool should have a slip fit in between the magnets without having to force the tool in place, and without any gaps between the tool and the magnets.

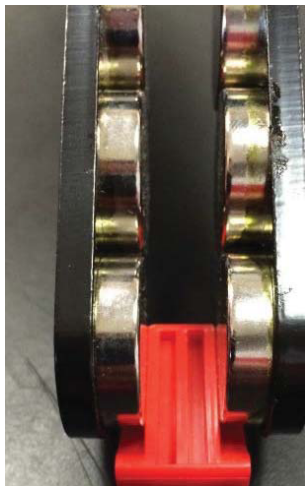

Correct Gap



Gap Too Large

- a. Place the calibration tool on the flywheel and rotate the flywheel so that the tool rests between the front set of magnets. Shown on the AC™ Sport for clarity in the pictures below. As can be seen in the figure on the right, the gap is too large in this case. The gap should be between 10.5 mm and 11 mm, using the calibration tool will set the gap correctly.



Correct Gap



Gap Too Large

- b. To adjust the magnet gap, carefully place a pair of soft-jaw pliers around the outside of the resistance mechanism plates, and squeeze. Make small adjustments at a time and check the gap with the tool fit—the fit should be a slip fit with no side-to-side play. Also ensure that the flywheel remains centered between the magnets.
2. The figures below show how to adjust the magnet gap on the various models. **NOTE: DO NOT USE ANY METAL TOOLS DIRECTLY ON THE SURFACE OF THE BRAKE CARRIAGE PLATES. DOING SO WILL DAMAGE THE CORROSION RESISTANT COATING.**

AC™ Performance

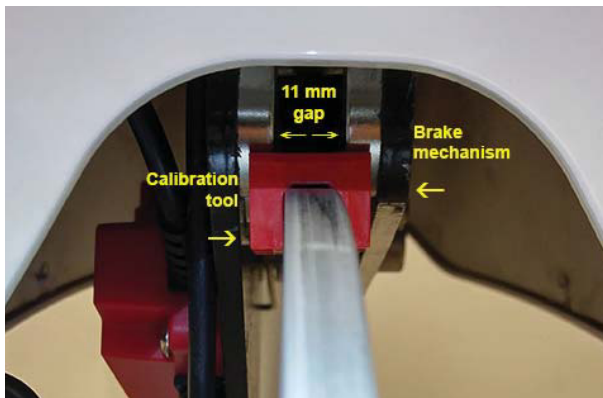

AC™ Performance Plus



AC™ Sport

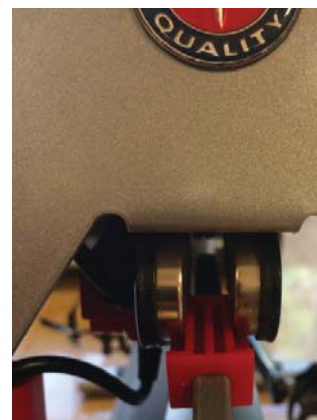

## FAQs

How is the Echelon2 console and power upgrade different from the Echelon?

- The power sensor has been replaced with a new sensor that is more stable and more accurate than the previous power sensor, and consumes less energy.
- The new power sensor uses an all new algorithm that provides more accurate and consistent power readings.
- The new power sensor has been simplified by removing the power sensor firmware.
- Now only the console contains the firmware that drives the whole system, and firmware updates for the entire system can easily be done through the USB drive.
- There is now a dedicated ON/OFF button at the top.
- The END button has been replaced by the AVG/MAX button.
- The term WATTS has been changed to POWER, though the units of power are still measured in watts.
- The speed display has been removed, and the heart rate, calories, and optional gear display have been moved up to the third line.
- There are now AVG and MAX power displays in the STAGE and TOTAL ride timers so that riders can see their total ride average power at all times, and they can now see their stage average power.
- The function of the STAGE button has changed so that one press starts a stage, a second press ends the stage and freezes the data, a third press clears the stage and begins a new stage.
- When a rider stops pedaling and the console enters Pause mode, the timers now will continue running for as long as the console is in Pause mode; however, the console will not continue counting average power until the rider begins pedaling again.
- The console connector has been redesigned and now has a protective cap that prevents the connector from accidentally being unplugged.
- The data file that can be uploaded to a USB drive displays summary data for the entire ride and for each stage, as well as total ride data.
- Improved battery life.

The Echelon2 console seems to report higher or lower power (watts) than the Echelon. Is the Echelon2 less accurate than the Echelon?

- The Echelon2 has been designed, tested, and validated to be more accurate than the Echelon. In some cases, the Echelon2 may report lower power (watts) than the Echelon due to improved accuracy. If riders are used to higher numbers and want to see higher numbers, then the PWR ADJUST feature in the service menu can be used to adjust the power display to be higher (or lower if desired). The PWR ADJUST feature allows you to adjust the power up or down between -99% and +99% to change the level of power that is displayed for a given level of resistance.

How does the Echelon2 measure power and how does that method of measurement differ from how other group cycling bikes measure power?

- The Echelon2 uses a simple and robust position sensor to measure the angle of the resistance mechanism. The console then uses an algorithm to calculate the power based on the angle of the resistance mechanism. The algorithm was developed using a laboratory dynamometer to validate the accuracy of the power algorithm, achieving a level of accuracy that is comparable to other group cycling power meters. Some other brands of group cycling bikes use strain gauges to measure torque or load. Strain gauges do not directly measure power either; they measure the strain of a particular component. They then provide electrical signals that must then be run through an algorithm, as is done with the Echelon2, to calculate power. All power meters, regardless of how they provide data, must be validated for accuracy. The Echelon2 power upgrade kit is the only power measurement device that can be bolted on by the user and does not require factory installation. In addition the sensor used in the Echelon2 is far less costly than strain gauge sensors, yet provides comparable accuracy.



How do I record my ride data using a USB drive?

- Insert a USB 2.0 drive into the USB port in the top of Echelon2 console before beginning the ride. Once the ride is finished, press and hold the AVG/MAX button on the console to end the ride. The console will then go into a ride summary screen and will then proceed to export the data from the ride to the USB drive. After 30 seconds the USB drive can be safely removed.

How do I manually end my ride?

- To manually end a ride, hold the AVG/MAX button for 5 seconds and the ride will end. Once the ride has ended a summary screen will be shown. It is during this summary screen when the console pushes ride data to the USB drive, if one is inserted into the console.

I see that the term “WATTS” was replaced by the term “POWER.” How does power differ from watts?

- Power is the correct term for the parameter while “watts” is the unit of measure of power. The power is still measured in watts; however, we changed the term to power since it is more meaningful to most people.

Is the Echelon2 power display limited to 999 watts like the Echelon?

- No. The Echelon2 is capable of displaying four digits for power, and so riders can now exceed 1000 watts

Why is speed no longer displayed on the Echelon2 console?

- On a stationary indoor cycling bike speed is a largely estimated number that provides little value given that the bike is not moving. Speed on an indoor bike is synonymous with power. Our education and development team feel that power is a more important training parameter with an indoor bike, so we added average and maximum power displays to the Stage and Total timers and eliminated speed in order to simplify the display and not have excess data points.

Why is distance still used on the Echelon2 when speed is not and how is distance calculated?

- Our education team feels that distance is a parameter that many of their riders like to see compared to speed, and that keeping distance is very important as it gives riders a benchmark to reach, especially when doing stages. Distance is calculated using an algorithm that is based upon power and simulates the distance one would travel on flat ground. With the Echelon2, riders can set distance goals for themselves for the ride or for stages, and use average power as a guide to help them be sure they will meet their goals.

How are gears calculated on Echelon2?

- Gears are an indicator of the level of resistance and are calculated from the angle of the resistance mechanism. On the Echelon2 we tightened up the range of gears so that there would not be as large of changes of resistance between gears when compared to the Echelon. The Echelon console has 19 gears while the Echelon2 has 36 gears.

Why am I not able to turn on the Echelon2 console by pressing any button like I was able to on the Echelon?

- On the Echelon2, we created a dedicated ON/OFF button at the top of the console. The console can be powered on or off using this button only.

How does the Stage timer on Echelon2 work?

- On the Echelon2, we changed the function of the Stage timer so that when stopping a stage, the data is frozen on the screen for the rider to see before starting another stage. To clear the data and begin a new stage, the rider simply needs to tap the STAGE button a second time.

Why is there a clicking sound coming from the speed (RPM) sensor? Is it broken?

- A faint clicking or ticking sound may be heard coming from the speed sensor while the bike is in use, this is normal operation. The clicking sound is the magnetic switch inside the sensor counting the RPMs and is a sign

that the sensor is operating correctly.

When I try to enter service mode, I am getting a screen that says "ENTER PASSCODE," what is the passcode and how do I enter it?

- The passcode is "218" To enter it, use the AVG/MAX button to scroll through a 1-9 number count, use the light button to accept the number once "2" "1" and "8" have selected.

How do I turn off/on the passcode lock for service mode?

- To turn off the passcode, enter service mode by holding the STAGE and AVG/MAX buttons at the same time until the passcode screen appears, enter "218" for the passcode, then use the AVG/MAX button to scroll until you see "PASSCODE" and press the light button to access the passcode options. From here, the passcode can be turned off or on.

Why do I have to calibrate the Echelon2 console monthly?

- The Echelon2 console is the most stable and reliable group cycle computer that Schwinn has ever produced. If you are encountering inaccurate watts/power/calories ensure that the console firmware is updated to V1.6 or greater; see below for instructions on how to check the firmware version. Always [perform the Zeropoint Calibration](#) with the calibration tool. [Ensure that the brake magnets are the proper width apart](#). If the console is being improperly calibrated, you may want to apply the passcode feature to keep unauthorized users from entering the service menu

The amount of calories that the console shows for my ride are lower than the amount of calories that my heart rate monitor says I burned. How are calories calculated on the Echelon2? Why are they lower than what my heart rate monitor says?

- Calories on the Echelon2 are calculated directly from the power, and are a true measure of the amount of energy expended by turning the pedals. The Echelon2 calories do not take into account any biological factors such as age, weight, and gender. The Echelon2 calories also do not take into account calories burned due to a person's normal metabolic rate. Heart rate monitors use heart rate, age, gender, and weight to estimate how many calories a person burns. The heart rate monitor not only accounts for work done on the bike, but also resting metabolic rate while doing the work. So the heart rate monitor calories will likely always be higher than the calories calculated by the Echelon2. The amount of difference between the two will depend on physical fitness level and biological factors of individual riders.

How do I check the current firmware version on the Echelon2 console?

- To check the current firmware version on the Echelon2 console, do the following:
  - i. Press the ON/OFF button at the top of the display
  - ii. Push and hold the STAGE and AVG/MAX buttons at the same time until "Carbon Blue" appears on the display, this is the landing screen for the service menu.
  - iii. Press the AVG/MAX button to scroll through the service menu until "SYSTEM" is displayed, then press the light button to enter the SYSTEM menu.
  - iv. The current firmware version will be displayed in the lower right corner of the display.

How do I update the firmware on the Echelon2 Console?

- The Echelon2 software will need to be transferred to a USB drive formatted for FAT32, as our console uses a FAT32 compatible USB drive. Any USB drive can be reformatted to use the FAT32 file system from a computer.
- To reformat a USB stick on a Windows computer, do the following:
  - i. Right click on the USB stick name in Windows Explorer. 2.
  - ii. Click on the FORMAT menu option.
  - iii. In the FORMAT menu, click on the FILE SYSTEM pull-down menu.



- iv. In the FILE SYSTEM pull-down menu, choose FAT32. All data on the USB stick will be deleted and the drive will now use the FAT32 system and should work with the console.
- v. Transfer the newest software onto the newly formatted USB stick for use in updating the console.
- vi. When the firmware file is loaded on the USB stick, it needs to be renamed "MPowerQ.bin".

NOTE: If updating from V1.1 firmware, do not include the Echelon2ID.txt file with the firmware, as it will reset console IDs that were previously set with V1.1.

- Updating the Echelon2 software:
  - i. Turn on the console by pressing ON/OFF button, then press and hold AVE/MAX & STAGE buttons simultaneously for 5 seconds. This will get you into the Service Mode.
  - ii. Press STAGE button until SYSTEM appears on the screen. Then press the LIGHT to enter the SYSTEM menu.
  - iii. Press STAGE button until LOAD FW command appears, then press the LIGHT button.
  - iv. INSERT USB command will appear, insert the USB into port at the top of the console.
  - v. Press the LIGHT button again and this will activate the loading process. This may take up to a minute to complete. If it does not finish after one minute, there may be an issue with the files (location on drive) or the USB. Remove the USB stick, power cycle the console, and try the update again from step 1. If the update still does not work, there may be an issue with the USB drive and/or files.
  - vi. When uploading the firmware, an error message ("WR ANTID" and "WRID ERR1") will pop up three times while the firmware is loading. This is ok. It just means that the firmware is looking for the ID file. After the third attempt to find the file, it bypasses the ID rewriting step and loads the firmware.
  - vii. Once loading is complete. The system will notify it has completed with "LOAD FW COMPLETE" message.

NOTE: After updating the Echelon2 firmware, please be sure to perform the [Zeropoint calibration procedure](#).

Two bikes are displaying the same data on the leaderboard system, why is that?

- When syncing MPower™ Echelon2 consoles with external leaderboard systems (e.g. Performance IQ), there have been some instances of consoles with duplicate IDs. In order for all consoles to pair with the leaderboard, each must have a unique ID. When consoles have duplicate IDs, they will show on the leaderboard as the same bike. For example when Bike A's console is synced to the leaderboard, it shows as Bike A. When Bike B's console is then synced to the leaderboard, it will also show as Bike A on the leaderboard. The chipsets used in this communication should have a unique ID but an investigation into this issue found some consoles with duplicate IDs. The solution is to [update the console to the latest firmware](#) (later than V1.0) then generate a new console ID in the service menu (see below).

**NOTE:** All consoles in a given studio should always have the new version of firmware loaded into the consoles when this issue arises. However, only one of two given consoles displaying duplicate IDs needs to have a new ID number generated. When updating the firmware in all consoles, each console will need to be repaired with the leaderboard system.

How do I assign a new console ID number?

1. Enter Service Mode again by pressing and holding the STAGE and AVG/MAX buttons.
2. Scroll to the SYSTEM menu by pressing the AVG/MAX button. Then press the LIGHT button to enter the SYSTEM menu.
3. Press the AVG/MAX button to scroll to the SYSTEM then scroll to SERIALNUM.
4. Press and hold the STAGE and AVG/MAX buttons until a new ID number is generated
5. Press the AVG/MAX button to the EXIT screen, and press the LIGHT to exit the SYSTEM menu. Then press the AVG/MAX button again to the EXIT screen and press the LIGHT button to exit the Service Mode.

NOTE: After generating a new console ID, the console will need to be re-synced to the leaderboard system.

Why won't my heartrate monitor / fitness tracker connect to the Echelon2?

- The Echelon2 console uses the ANT+ technology to connect to a variety of heartrate monitors and fitness trackers. The first step is to ensure that the device you are using is compatible with ANT+. For a list of supported devices, please visit [www.thisisant.com](http://www.thisisant.com).

How do I pair my heartrate monitor (HRM) or fitness tracker with the Echelon2 console?

- After powering the console on, but before beginning a ride:
  - i. ANT+ watch: Move the watch to 2"-4" (5-10 cm) or less from the ANT+ Link Here icon on the console and hold it there until proximity linking is complete.
  - ii. ANT+ HRM: Lean into the console so that the HRM is 7.5"-31" (20-80 cm) from the ANT+ Link Here logo, until a value is displayed.